

Signature
EDITION™

ALARIS™

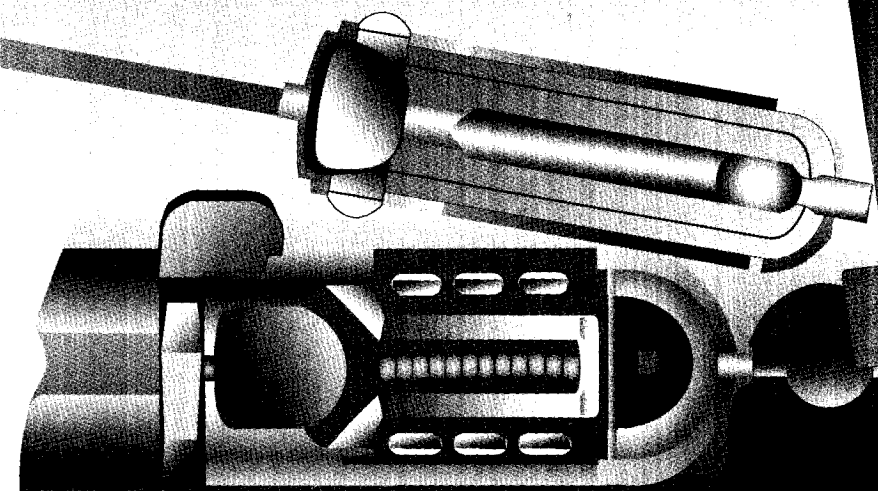

**VOLUMETRIC
INFUSION PUMPS**
IVAC® Models 7100 & 7200
Directions For Use

TABLE OF CONTENTS

| | |
|---|-----|
| INTRODUCTION | |
| ABOUT THE PUMPS..... | 3 |
| FEATURES..... | 6 |
| CONTROLS AND INDICATORS..... | 10 |
| DISPLAYS..... | 12 |
| AROUND THE PUMP..... | 14 |
| GETTING STARTED | |
| OPERATIONAL PRECAUTIONS..... | 15 |
| PREPARING THE INFUSION..... | 18 |
| START UP SEQUENCE..... | 20 |
| PRIMARY MODE..... | 22 |
| KVO MODE..... | 26 |
| SECONDARY MODE..... | 28 |
| UNLOADING THE SET..... | 34 |
| TO TURN PUMP OFF..... | 34 |
| ALARMS, ALERTS, AND PROMPTS..... | 35 |
| FEATURES AND OPTIONS | |
| BATTERY MANAGEMENT SYSTEM..... | 47 |
| NURSE CALL..... | 48 |
| PANEL LOCK..... | 49 |
| POLE CLAMP..... | 50 |
| AIR-IN-LINE RESET..... | 51 |
| DYNAMIC MONITORING™ SYSTEM..... | 52 |
| DRUG-SPECIFIC DOSE RATE CALCULATOR..... | 60 |
| MULTI-STEP PROGRAM..... | 73 |
| MULTI-DOSE PROGRAM..... | 82 |
| LOADING DOSE..... | 89 |
| COMPUTER LINK..... | 93 |
| MAINTENANCE | |
| SPECIFICATIONS..... | 95 |
| PROGRAMMABLE FEATURES..... | 97 |
| UNPACKING..... | 98 |
| STORAGE..... | 98 |
| CLEANING..... | 99 |
| INSPECTION REQUIREMENTS..... | 100 |
| SERVICE INFORMATION..... | 101 |
| WARRANTY..... | 102 |
| APPENDIX..... | 103 |



INTRODUCTION

INTRODUCTION

About The Pumps

The IVAC Signature Edition™ Infusion System includes the Model 7100 and Model 7200 Volumetric Infusion Pumps and AccuSlide™ Flow Regulator administration sets. This document provides directions for use for both model pumps.

- The single channel provides a full range of features in a small, easy-to-use, linear peristaltic pump.
- The dual channel offers the same features while providing two, independent infusion pumps in one instrument.

The pumps may be used to deliver a wide variety of fluids over a broad range of infusion rates from multiple fluid container types.

The system is designed to be used in many areas of patient care, including:

- General Floor
- Medical/Surgical
- ICU/CCU
- Pediatrics
- Neonatology
- Labor/Delivery/Post Partum
- OR/Anesthesia
- Post Op/Recovery
- Cardiac Cath Lab
- Emergency
- Burn Unit
- Hemodialysis
- Oncology
- Mobile Intensive Care
- Nutritional

The pumps' applications include:

- General IV fluids and electrolytes
- Antibiotics
- Blood and blood products
- Epidural
- Enteral solutions
- TPN and hyperalimentation products
- Lipids
- Solutions for irrigation procedures
- Anesthetics and analgesics
- Cardiovascular drugs

The Signature Edition Infusion system uses a **wide variety of AccuSlide Flow Regulator administration sets**. The IVAC 72 series sets are designed for use within the pumps as well as for gravity-flow, stand-alone use. The unique, patented AccuSlide Flow Regulator has an integral flow control device that minimizes accidental free-flow when the set is removed from the pump and provides accurate rate control during gravity administration.

The Signature Edition infusion system incorporates a **dramatically improved method of detecting full and partial occlusions** which, depending on the situation, requires little or no clinician involvement. The Dynamic Monitoring™ system evaluates line pressure and fluid flow to help the clinician assess the quality of the infusion. Features include: monitoring options to provide resistance, high resistance and pressure monitoring of infusion site; AutoRestartPlus™ operation, to automatically continue the infusion if an occlusion is relieved during the self-check time; a Resistance Alert, which may be set by the clinician as an early warning to increases in flow resistance; and a Resistance Trend Graph, to give a visual representation of resistance over time.

The pumps are equipped with a **unique battery display** that provides the clinician continuous monitoring of battery time available, indicated in 15 minute increments. This information is displayed when the instrument is turned on.

A **dual rate feature** allows the pumps to administer both primary and secondary solutions at separate flow rates and volumes. Using this feature, the clinician can select and start a program for secondary (piggyback) medication. Upon completion of the secondary dose, the pumps will automatically switch over to a primary rate. Both channels of the Model 7200 can be programmed for primary and secondary operation.

The panel lock feature helps prevent tampering. A panel lock symbol (🔒) is shown in the lower display when the panel lock is on, and no changes can be made from the front panel. The panel lock key is readily accessible yet not obvious to unauthorized users.

Optional modes are easily accessed with the press of one key.

The **Drug-Specific Dose Rate Calculator** allows the clinician to select a drug name, and calculate a volumetric or dose rate for continuous infusion. Once calculated, the pumps will display the drug name on the screen. A generic

calculator is also provided for drug names not on the drug list.

The **Multi-Step program** allows a sequential program to deliver up to nine steps; fluid volumes and delivery rates may be programmed for each step. The program may be entered based on Rate and Volume, or Volume and Time.

The **Multi-Dose program** allows the clinician to preprogram multiple infusions over a period of up to 24 hours; the fluid volume and delivery rate is repeated for each delivery. A delayed start feature may be programmed.

The **Loading Dose feature** allows the clinician to set up an initial infusion rate for a specific volume, automatically followed by a maintenance rate from the same container.

The **flow sensor feature** allows the clinician to be notified if container(s) is empty and/or upstream occlusions are present.

Qualified service personnel can **configure many features** of the pump to meet specialized needs. The  symbol is used throughout this document to indicate the programmable features. See the SPECIFICATIONS section of this document for a list of the programmable features and the default settings. Refer to the Technical Service Manual for the procedure to set selected configuration parameters.

Features

Simple 2-step loading

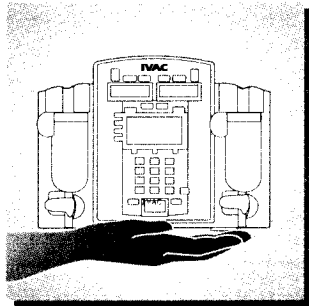
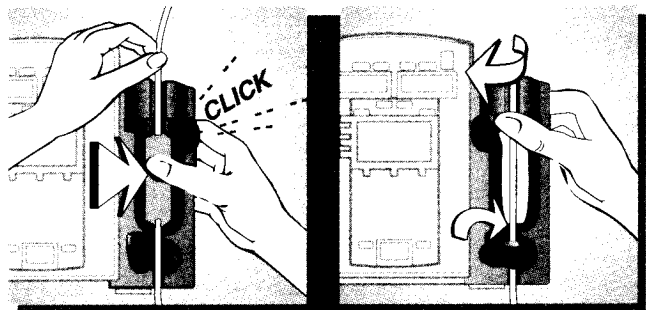

Lightweight and portable

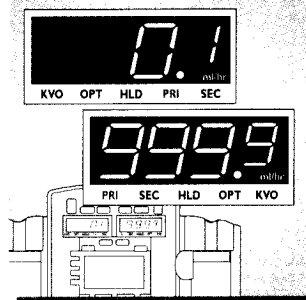

Rates from 0.1 to 999.9 ml/hr

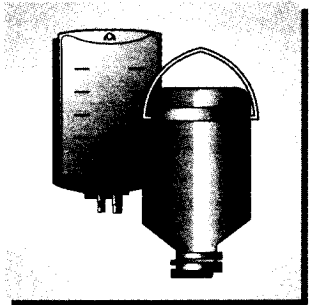

Delivery from multiple containers

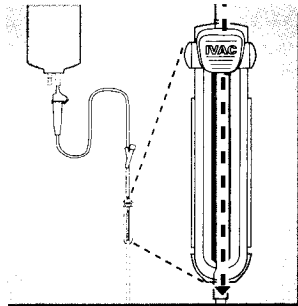

Easy gravity prime set for hospital-wide standardization

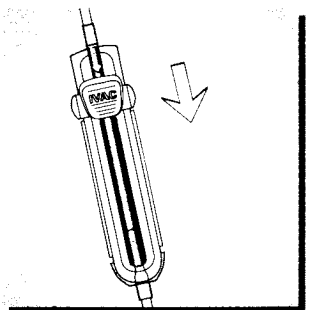

Anti-free-flow sets

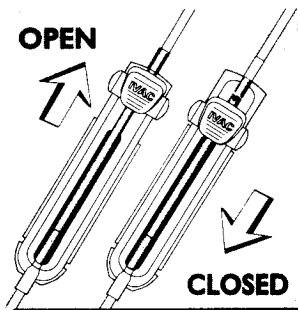

AccuSlide™ Flow Regulator

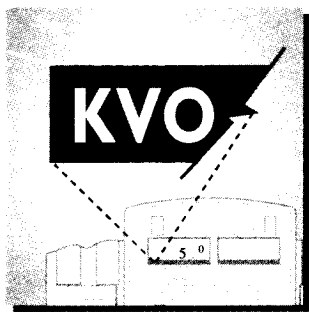

Automatic keep-vein-open (KVO) mode

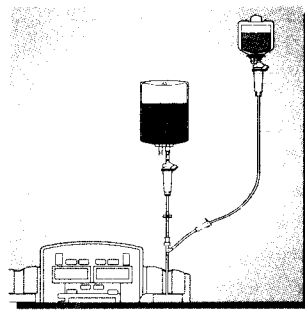

Dual rate for secondary delivery

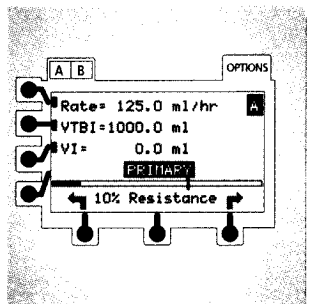

Dynamic Monitoring™ system

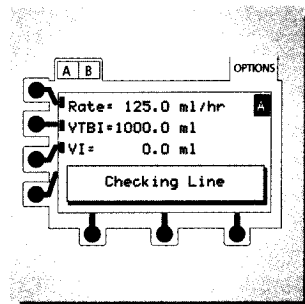

AutoRestartPlus™ operation

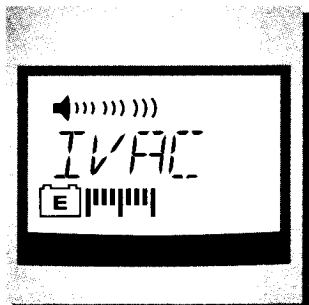

Battery status is continuously displayed 15 minute increments

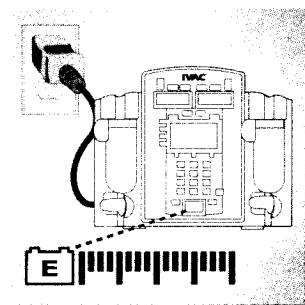

Automatic quick recharge of battery; 4 hours to 95% charge

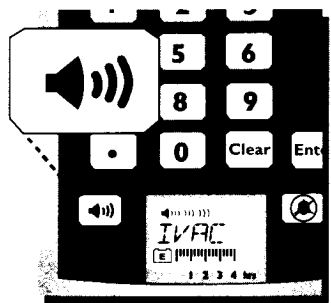

Adjustable audio volume

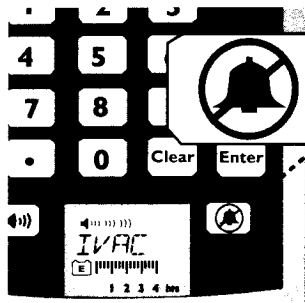

Temporary alarm and alert silence key

FEATURES

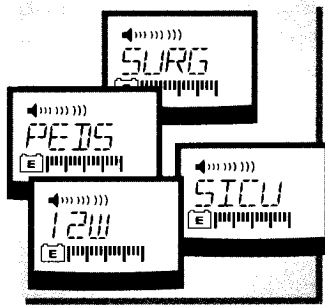

Customizable instrument ID label

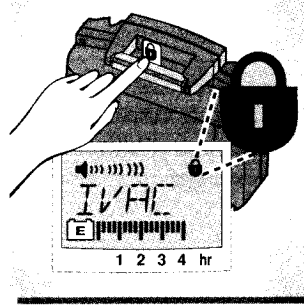

Panel lock helps prevent unauthorized changes

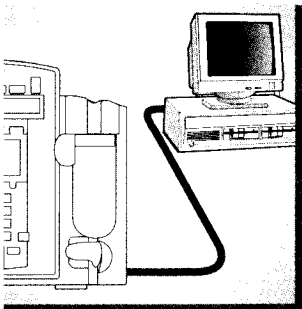

Computer monitoring capability

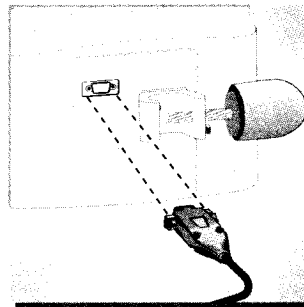

Learn/Teach configurations through RS 232 connection



Optional remote nurse call

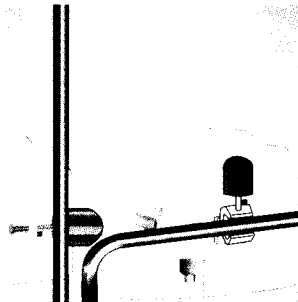

Rotating pole clamp

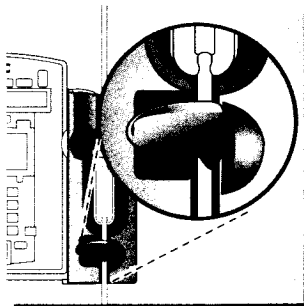

Configurable air-in-line detector

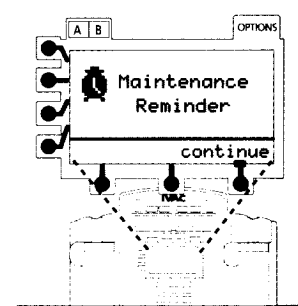

Periodic maintenance reminder



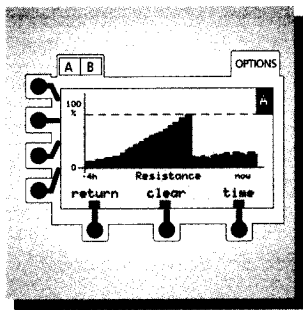

Resistance Trend Graph

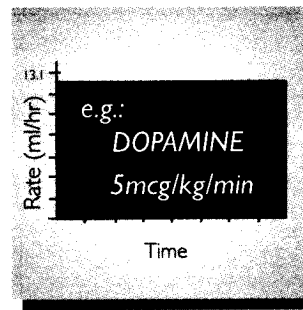

Drug-Specific Dose Rate Calculator

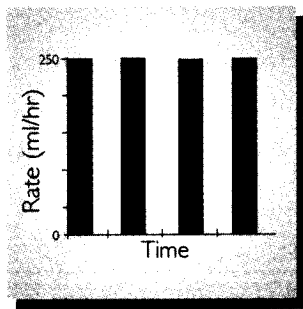

Multi-Dose Programming

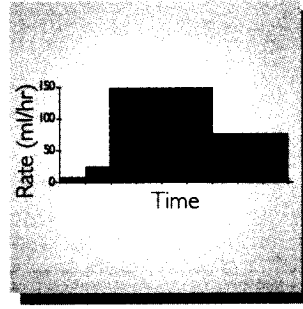

Multi-Step Programming

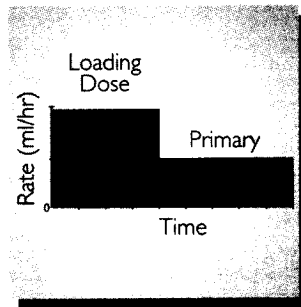

Loading Dose Program



Controls And Indicators

Model 7200 Controls and Indicators

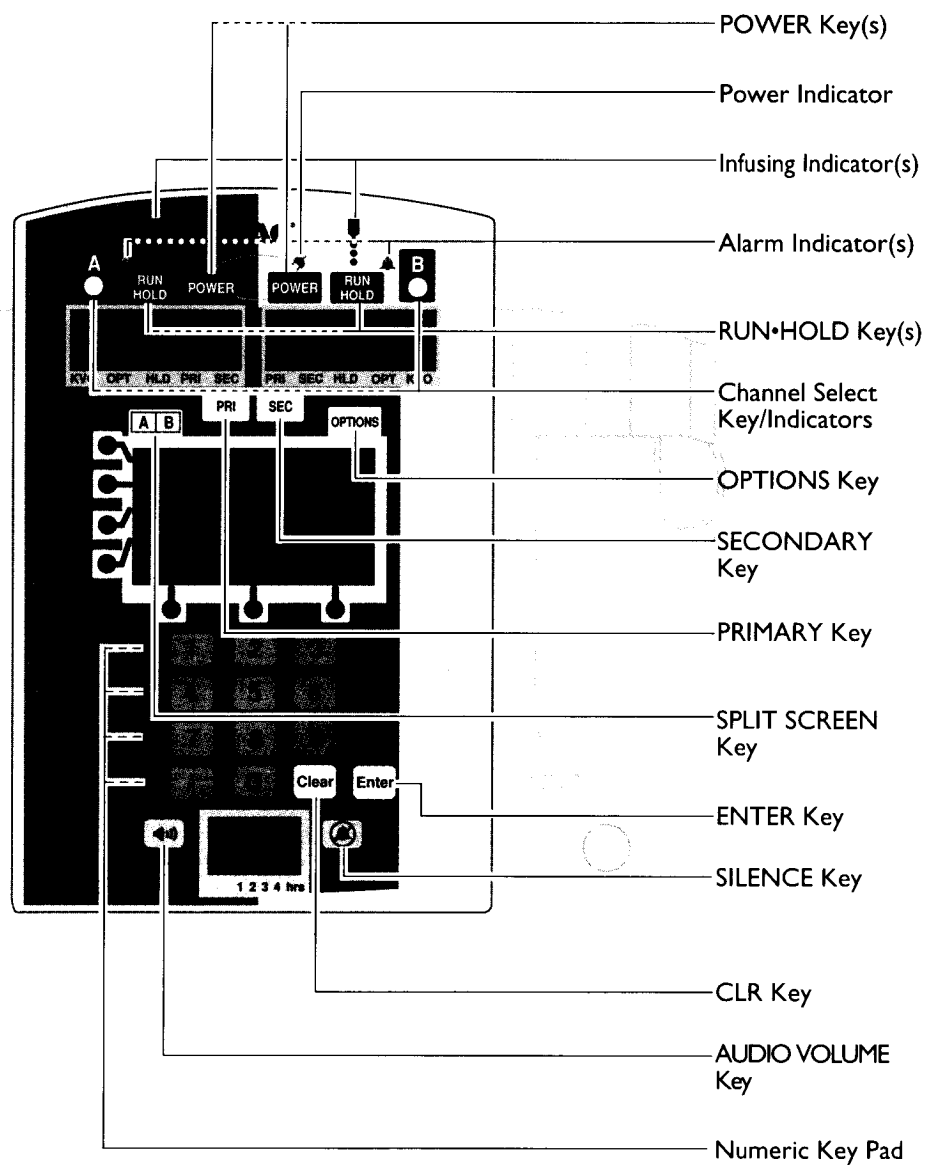

Model 7100 Controls and Indicators

Turns pump (7100) or channels (7200) on and off.

Green = Plugged in and charging
Flashing Yellow = Battery Power

Indicates pump (7100) or channels (7200) are infusing.

Indicates the pump (7100) or a channel (7200) is in alarm and has stopped infusing.

Starts and stops infusion.

Selects channel A or B. Lights to indicate which channel is selected. (7200 only)

Accesses additional features.

Selects secondary mode. (7200: Channel must be selected.)

Selects primary mode. (7200: Channel must be selected.)

Displays information for both channels when both channels are infusing. (7200 only)

Accepts value or selection entered.

Silences audible alarm or alert for two minutes; message remains on screen. New alarm or alert will reinstate audible tone.

Clears selected numeric value.

Sets audio volume for alarms and alerts.

Enters/changes values.

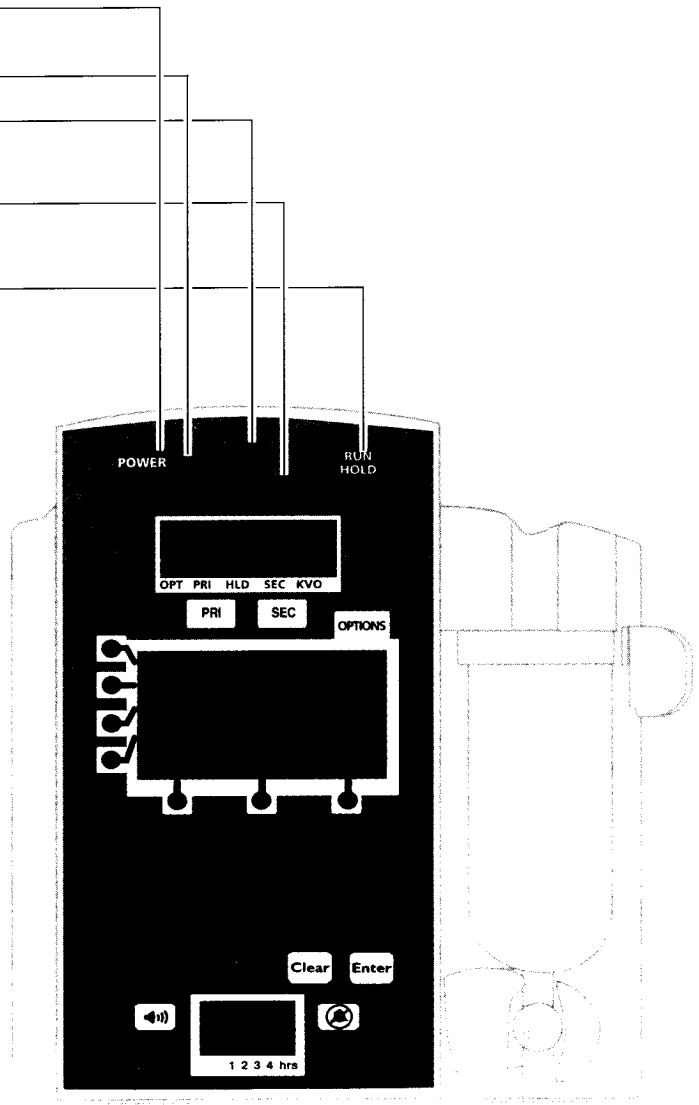

Displays

Main Display (Model 7100 and 7200)

The main LCD display is backlit for easy viewing. The backlight dims when operating on battery power as an energy-saving feature. Pressing any key automatically turns the backlight up again.

Channel Indicator (Model 7200 only)

Indicates which channel is currently selected.

Highlight

Indicates value is selected. Values must be highlighted to be changed.

Soft Keys

The keys on the side and bottom of the main display serve a variety of functions. What each key does is indicated by the text in the display at the time.

"Active" Soft Keys

Indicated by "TICK" (■) mark next to the key.

1. Press an active key to **HIGHLIGHT** desired area in the display.
2. Enter value using numeric key pad.
3. Press **Enter** to accept the value highlighted.

"Inactive" Soft Keys

Indicated by no "TICK" marks at the left and bottom edges of the display.

Split Screen (7200 only)

When both channels are infusing, the split screen showing programmed information is displayed after one minute. Pressing **A B** shows the split screen immediately.

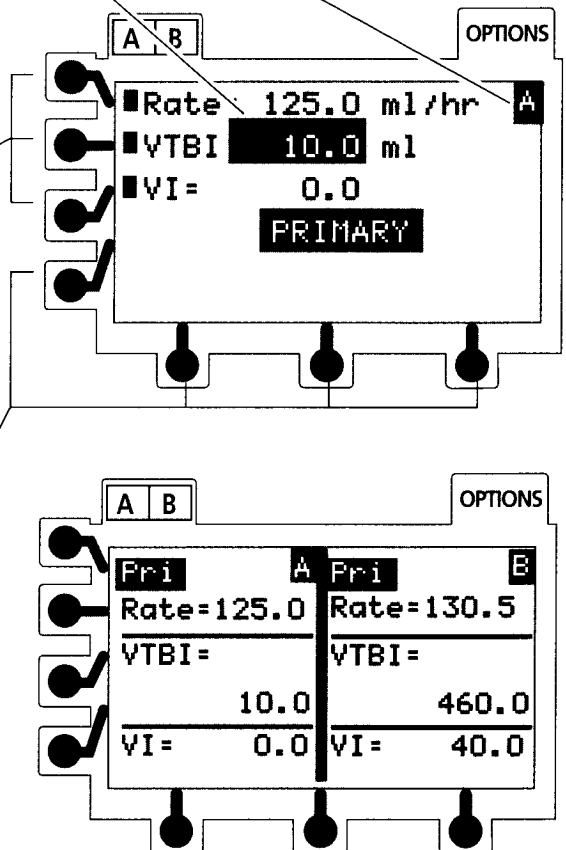

Rate Display(s)

The LED rate display is easily viewed from a distance.

Rate Display(s)

Indicates current infusion rate(s) in ml/hr.

Model 7100 Status Bar

Indicates which mode the pump is in:
Options, Primary, Hold, Secondary, or KVO.



Model 7200 Status Bars

Indicate which mode each channel is in:
KVO, Options, Hold, Primary, or Secondary.

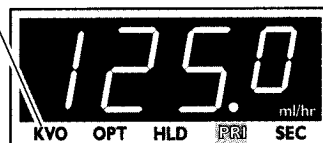

Lower Display

The lower LCD display is backlit for easy viewing. The display dims when operating on battery power as an energy-saving feature.

Panel Lock Indicator

Displayed if panel lock is on.

Computer Mode Indicator

Displayed if pump is in computer monitor or control mode.

Audio Volume Indicator

Indicates audio volume for alarms and alerts.

Instrument ID Label

Characters are entered by qualified service personnel to identify configuration, "ownership," location, etc.

Battery Power Gauge

Indicates battery time remaining in hourly increments.

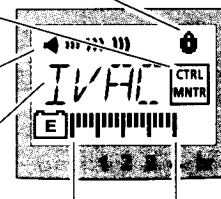

Instrument label is always displayed even when the pump is turned off.

AROUND THE PUMP

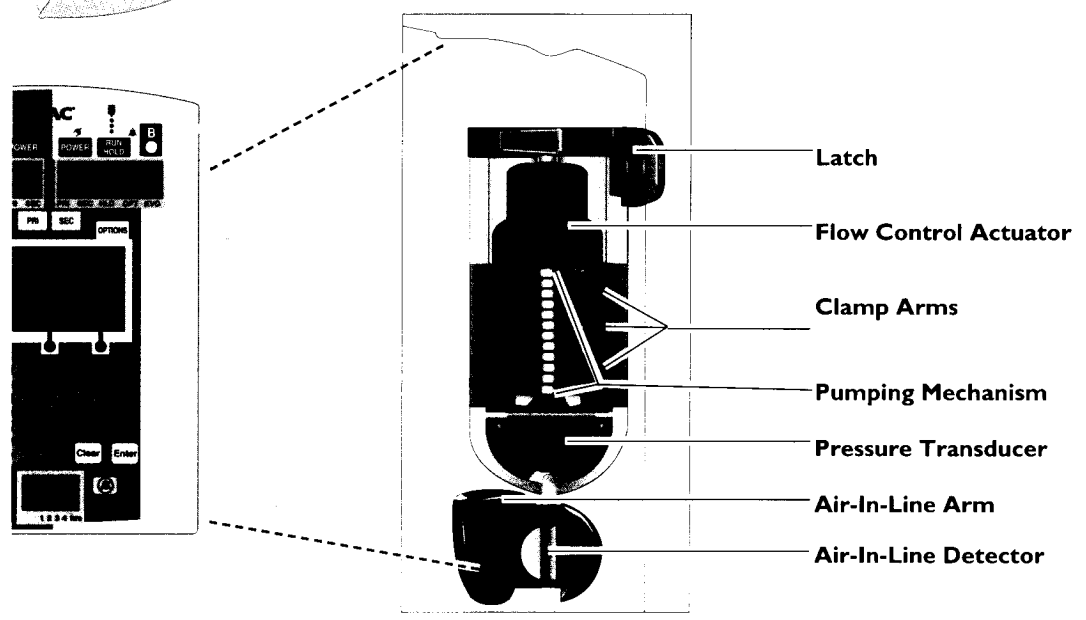
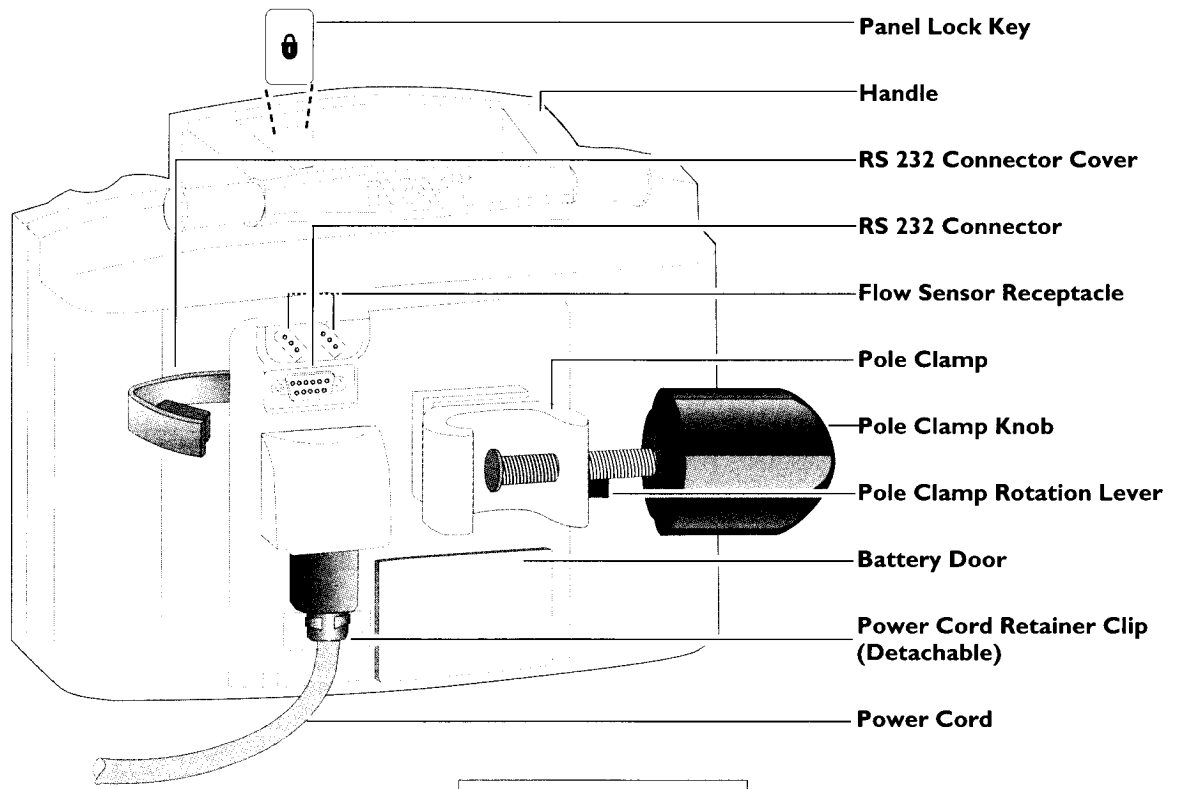

Patient Precautions

To avoid possible injury to the patient, observe the following precautions:

Epidural Administration

- The pump can be used for epidural administration of anesthetic and analgesic drugs. This application is only appropriate when using analgesics and anesthetics labeled for continuous epidural administration and catheters intended specifically for epidural use. Use only an IVAC 72 series set, **without** a 'Y' connector or injection port, for epidural infusions. The pump's secondary features must **not** be used when the pump is being used for epidural administration of anesthetic and analgesic drugs.
- Epidural administration of anesthetic drugs - Use indwelling catheters specifically indicated for short-term (96 hours or less) anesthetic epidural drug delivery.
- Epidural administration of analgesic drugs - Use indwelling catheters specifically indicated for either short-term or long-term analgesic epidural drug delivery.
- **WARNING:** Epidural administration of drugs other than those indicated for epidural use could result in serious injury to the patient.
- **WARNING:** It is strongly recommended that the infusion pump, source container and administration set used for epidural drug delivery be clearly differentiated from those used for other types of administration.

CAUTION: Federal (U.S.A.) law restricts this device to sale by or on the order of a physician.

WARNING: This pump is designed to stop fluid flow under alarm conditions. Periodic patient monitoring must be performed to ensure the infusion is proceeding as expected.

WARNING: Hospital personnel must ensure the compatibility of the drugs as well as the performance of each pump as part of the overall infusion. Potential hazards include drug interactions, inaccurate delivery rates, inaccurate pressure alarms, and nuisance alarms.

WARNING: The use of positive displacement infusion devices ported together with gravity flow infusion systems into a common IV site may impede the flow of common "gravity only" systems affecting their performance (hospital personnel must ensure the performance of the common IV site is satisfactory under these circumstances).

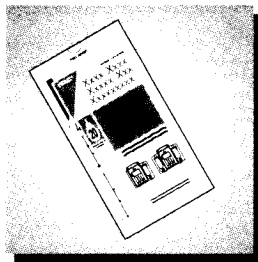

Administration Sets

- Use only IVAC 72 series administration sets. The use of any other set will cause improper pump operation resulting in inaccurate fluid delivery.
- Before operating the pump, verify that the administration set is free from kinks and installed correctly in the instrument.
- IVAC sets are supplied sterile for one-time use only. Do not resterilize.

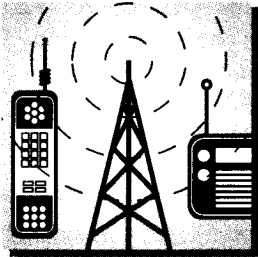

Radio Frequency Interference

- Operating the pump near equipment which radiates high energy radio frequencies (electrosurgical/cauterizing equipment, portable radios, cellular telephones, etc.) may cause false alarm conditions. If this happens, reposition the pump away from the source of interference; or turn off the pump and manually regulate the flow with the AccuSlide Flow Regulator regulating clamp.



Artifacts

- It is normal for infusion devices to produce non-hazardous currents when infusing electrolytes. These currents vary proportional to the infusion device flow rate. When the ECG monitoring system is not functioning under optimal conditions, these currents may appear as artifacts, simulating actual ECG readings. To determine if ECG abnormalities are caused by patient condition or the ECG equipment, place the infusion device on hold. If the ECG readings become normal, the ECG equipment requires attention. Proper setup of the ECG equipment should eliminate these artifacts. Reference the appropriate ECG monitoring system documentation for instructions on setup and maintenance.

Dropping/Jarring

- Should an instrument be dropped or severely jarred, the instrument should be immediately taken out of service and inspected by qualified service personnel to ensure its proper function prior to reuse.

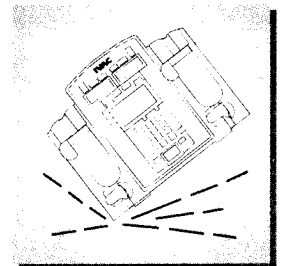

User Precautions

To ensure proper performance of the pump and to reduce potential injury to the operator, observe the following precautions:

- The power cord must be connected to a properly grounded 3-wire receptacle ("Hospital Grade").
- Not for use in the presence of flammable anesthetics.
- Do not open the instrument case. There are no user-serviceable parts inside. The case should only be opened by qualified service personnel using proper grounding techniques. When the case is opened, an electrical shock hazard exists which can result in serious injury to persons and instrument component damage.

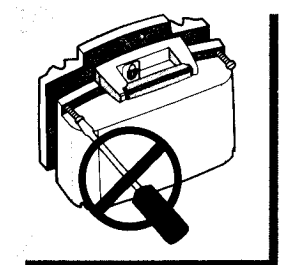
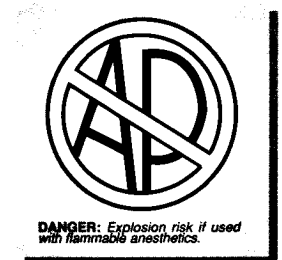
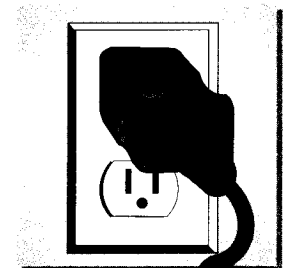

Preparing The Infusion

Preparing the Primary Solution Container

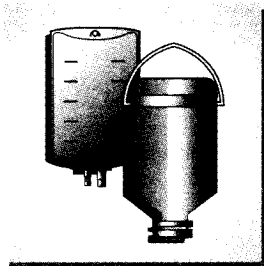

Prepare the primary solution container in accordance with the manufacturer's directions for use.

Preparing the Primary Administration Set

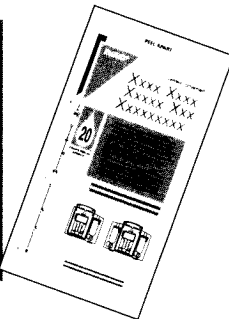
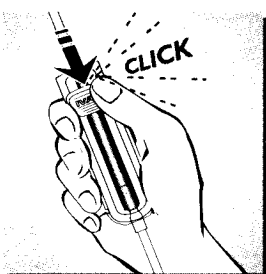

Use only an IVAC 72 series administration set. Refer to the set Directions for complete information.

- Move the AccuSlide Flow Regulator clamp down until it "clicks" closed.

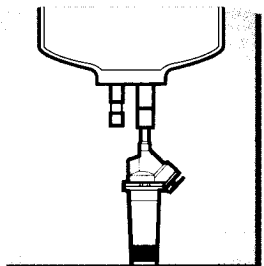

- Spike the solution container.
- Fill the drip chamber to the fill line.

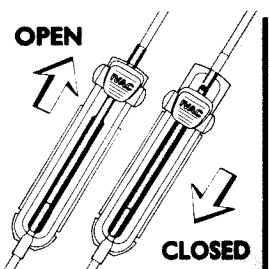

- Open the AccuSlide Flow Regulator clamp to prime the set.
- Close the AccuSlide Flow Regulator clamp when priming is complete. A gravity flow rate may be adjusted with the AccuSlide Flow Regulator clamp, if desired.

Loading the Primary Administration Set

- 1** Ensure the AccuSlide Flow Regulator clamp is in the off position. It will “click” when fully closed.

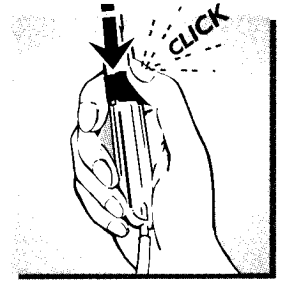

- 2** Press the AccuSlide Flow Regulator segment into the pumping area until it snaps into place.
 - Verify the tubing is in the air-in-line detector.

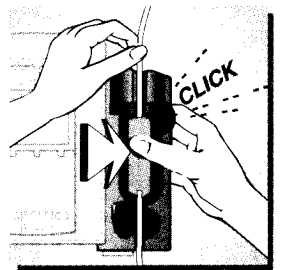

- 3** Close the latch **fully** to the left.
 - Closing the latch automatically
 - rotates the air-in-line arm over the tubing,
 - engages the pumping mechanism to occlude the flow,
 - opens the AccuSlide Flow Regulator clamp.

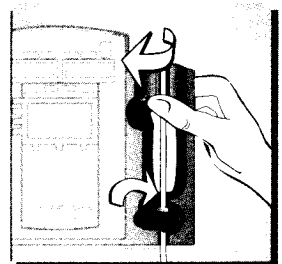

- 4** Check the administration set's drip chamber to verify no fluid is flowing.

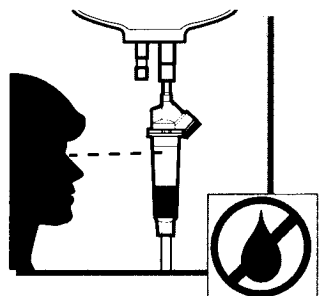

Start Up Sequence

- 1 Press **POWER** to turn channel on.
 - Instrument will perform a self test.
 - All indicators and displays will light momentarily.
 - Pump will beep.
 - System start up page will be displayed.
 - Mode indicator in status bar will be lit.
 - Hold indicator in the status bar will be flashing.

When self test is complete, primary setup page is displayed.

Instrument is ready for programming.

Pre-run prompts may appear if special operating modes were interrupted in the previous six hours. Refer to the DISPLAY MESSAGES section to determine appropriate action.

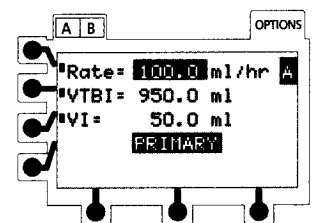
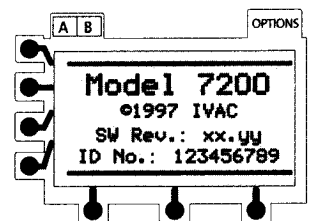

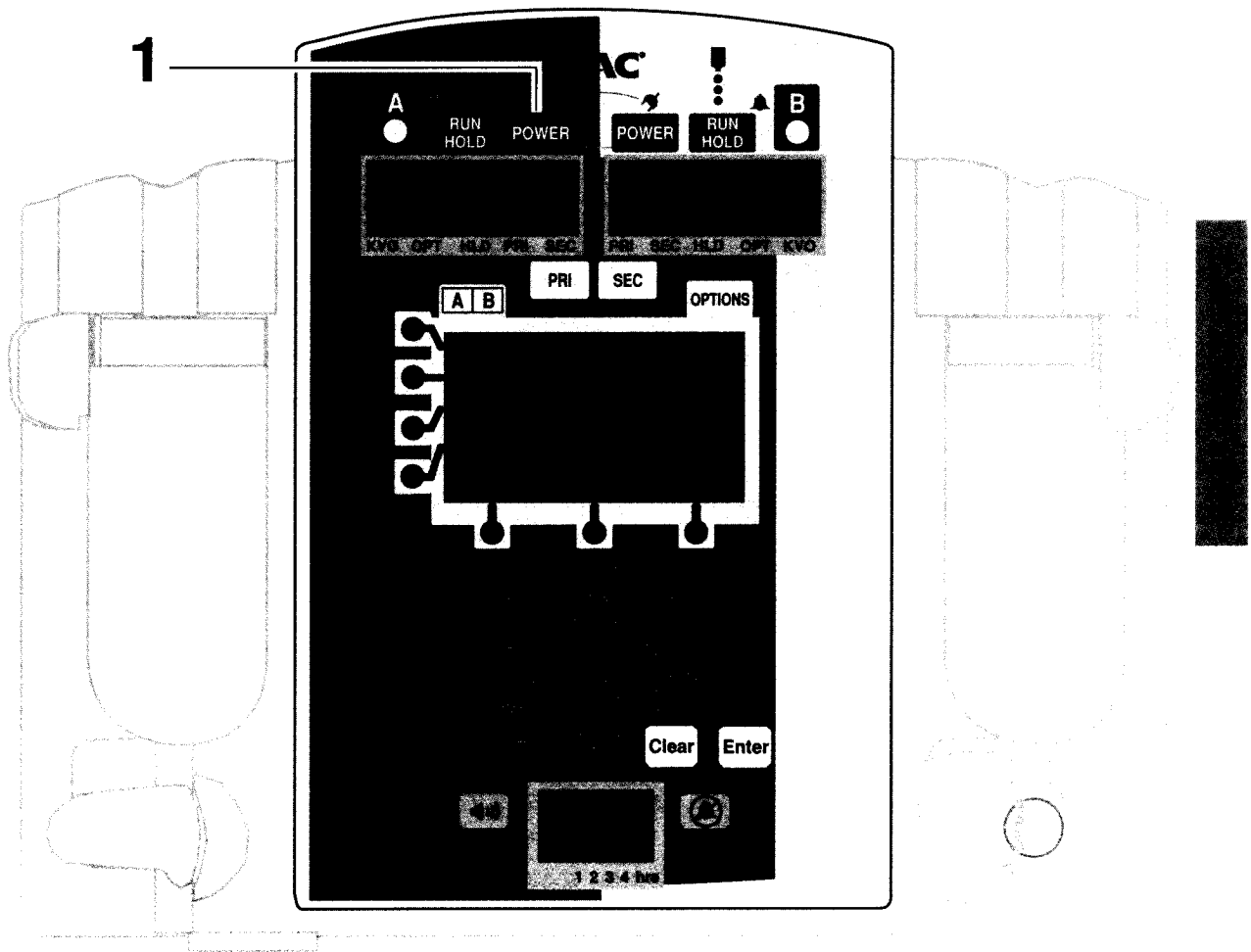

Primary Mode

- 1 Press **POWER** to turn channel on.
 - Primary setup page will appear.
 - Primary infusion rate will be highlighted.

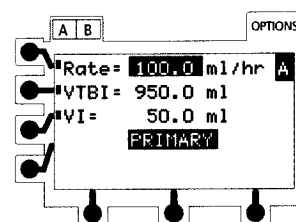

- 2 If current primary infusion rate is appropriate, press **Enter**.
OR
 Use numeric key pad to enter new infusion rate. Press **Enter**.
 - Primary VTBI (volume to be infused) will be highlighted.

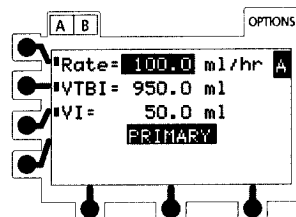

- 3 If current primary VTBI is appropriate, press **Enter**.
OR
 Use numeric key pad to enter new VTBI. Press **Enter**.
 - VI (volume infused) will be highlighted.

NOTE: If the flow sensor option is being used, VTBI can be turned OFF by selecting VTBI, then pressing **Clear**.

OR
 Primary VTBI can be deleted from the primary mode setup page (Programmable Features)

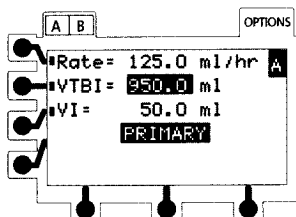

- 4 To clear VI, press **Clear** or 0 (zero key). Press **Enter**.
 - Volume infused will be reset to 0.0 ml.

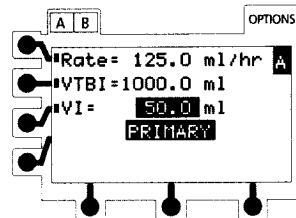

- 5 Press channel's **RUN HOLD** to start primary infusion.
 - Channel's infusing indicators will light.

Pre-run prompts may appear if start-up procedures were not completed. Refer to the DISPLAY MESSAGES section to determine appropriate action.

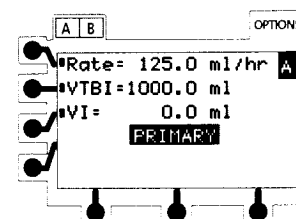

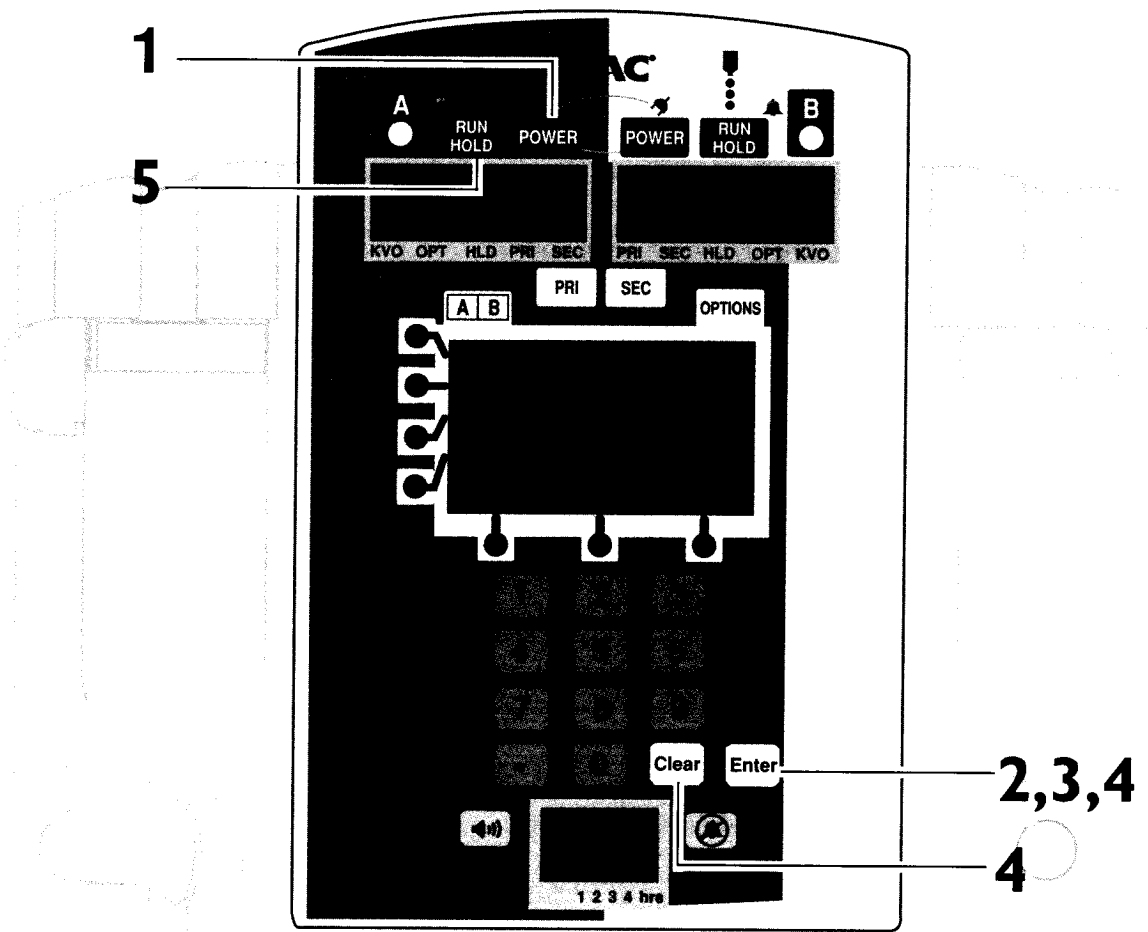

Making Changes During Primary Mode

Select desired channel, as necessary. The channel does not need to be on hold to change or clear settings for Rate, VTBI or VI.

- 1 Press soft key for value you want to change.
 - Current value will be highlighted.

To Change Primary Infusion Rate:

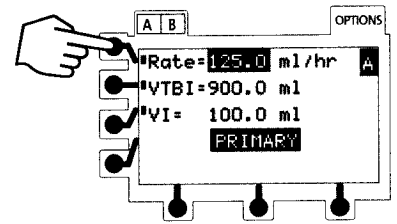

To Change Volume To Be Infused:

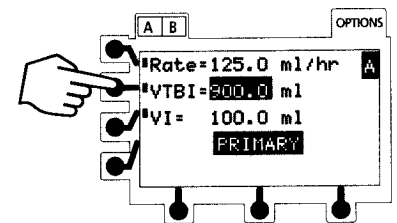

NOTE: If the flow sensor option is being used, VTBI can be turned OFF by selecting VTBI, then pressing **Clear**

OR

Primary VTBI can be deleted from the primary mode setup page (Programmable Features)

To Clear Volume Infused:

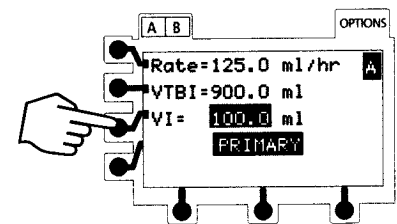

- 2 Use numeric key pad to enter new value.

OR

- 3 Press **Clear** or 0 (zero key) to reset volume infused to 0.0.

- 4 Press **Enter** to accept new value(s).

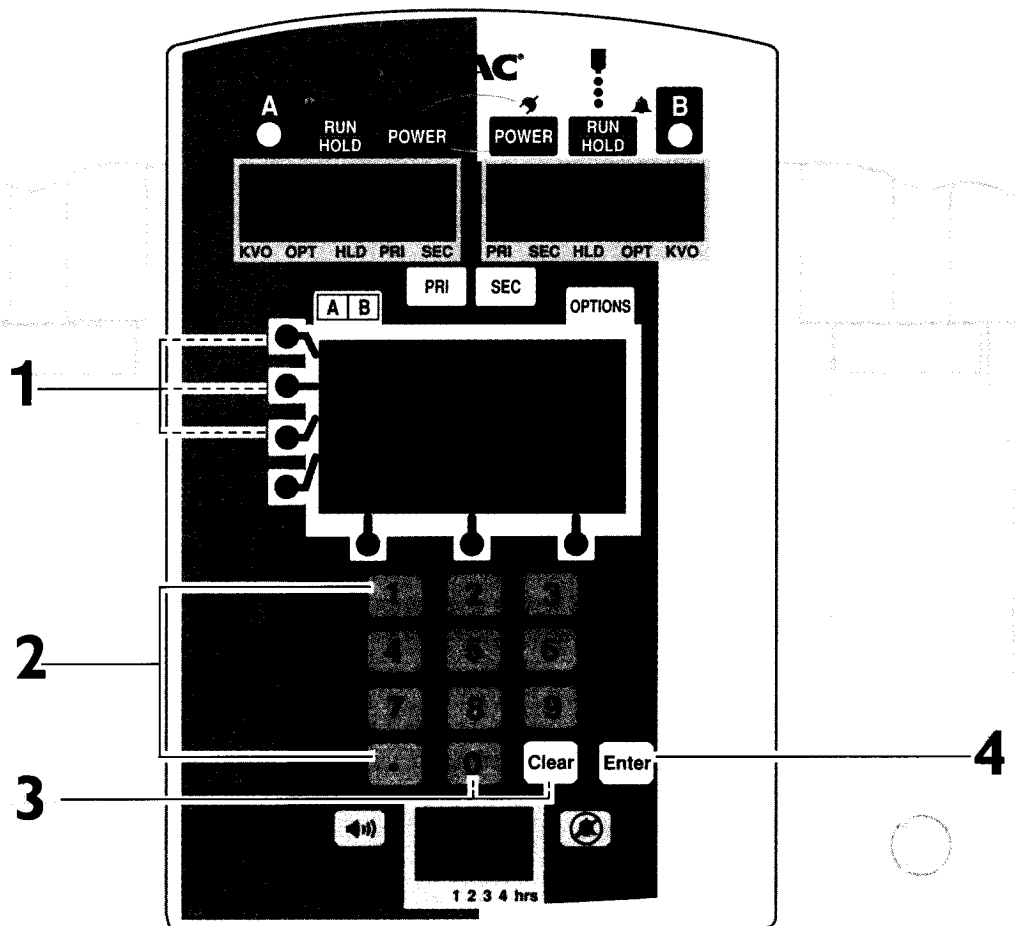

KVO Mode

KVO (keep-vein-open) mode automatically occurs when the primary VTBI has counted down to 0.0 ml. Channel switches to the pre-set KVO rate or remains at current rate, whichever is less.

- KVO rate is displayed in the rate display.
 - Main display will continue to show programmed infusion rate.
- KVO alert tone sounds.

The **VTBI=0** message and alert tone will continue until the channel is placed on hold.

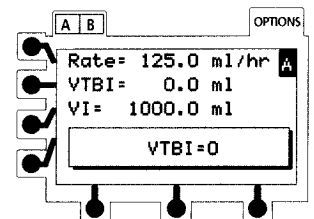
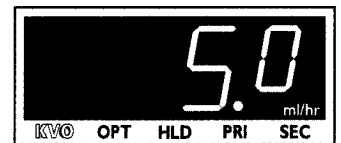

To Resume Primary Operation From KVO

Select desired channel, as necessary.

- 1 Press channel's **RUN HOLD** to place channel on hold.
- 2 Press **VTBI** soft key.
 - Primary VTBI will be highlighted.
- 3 Use numeric key pad to enter new VTBI.
- 4 Press **Enter** to accept new value.
- 5 Press channel's **RUN HOLD** to resume primary infusion.

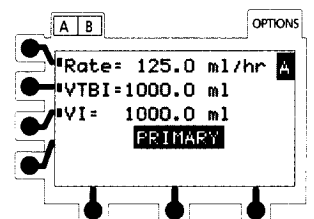
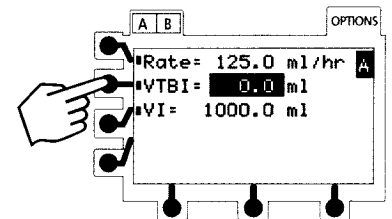

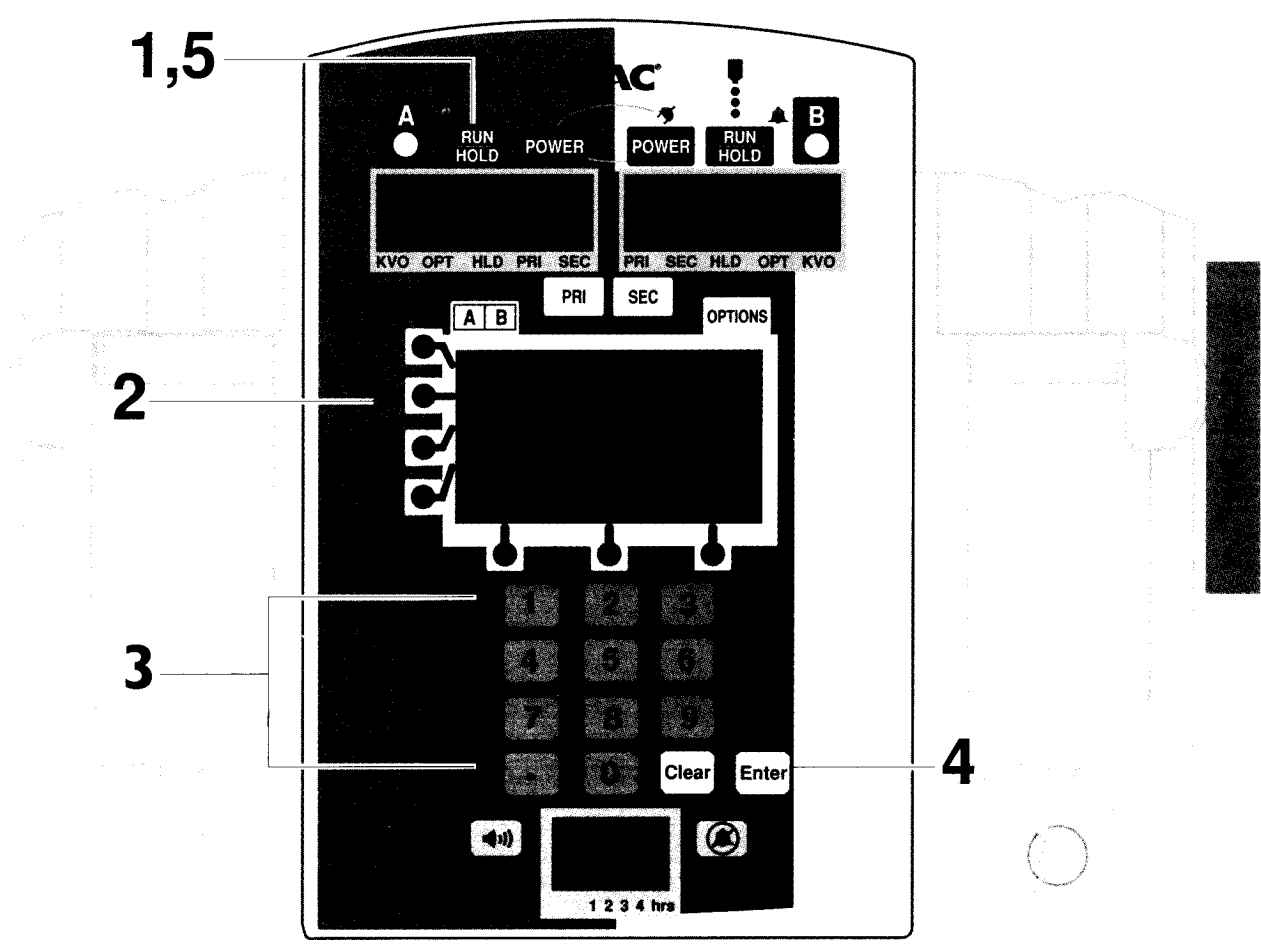

Secondary Mode

This mode is designed to support automatic secondary infusions ("piggybacking") in the same pump channel. It can be used where a second, independent volume to be infused with an automatic rate change is useful. When the secondary VTBI reaches zero, a transition tone will sound (if the transition tone feature is enabled), **Secondary Complete** message will be displayed for a few seconds, and the primary settings will automatically take effect.

Both channels of the Model 7200 can be programmed for primary and secondary operation.

- 1 Press channel **POWER** to turn channel on.
 - Primary setup page will appear.
 - Verify primary settings are appropriate.

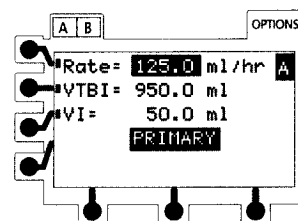

- 2 Press **SEC**.
 - Secondary setup page will appear.
 - Secondary infusion rate will be highlighted.

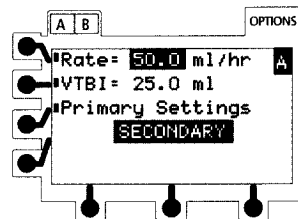

- 3 If current secondary infusion rate is appropriate, press **Enter**.
OR
Use numeric key pad to enter new infusion rate. Press **Enter**.
 - Secondary VTBI (volume to be infused) will be highlighted.

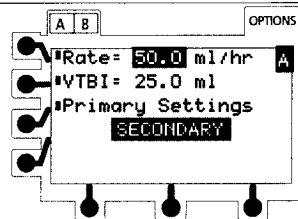

- 4 If current secondary VTBI is appropriate, press **Enter**.
OR
Use numeric key pad to enter new VTBI. Press **Enter**.

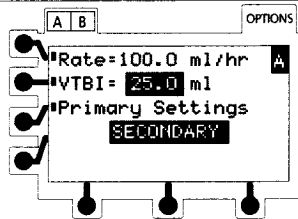

- 5 Press channel's **RUN HOLD** to start secondary infusion.
 - Channel's infusing indicators will light.

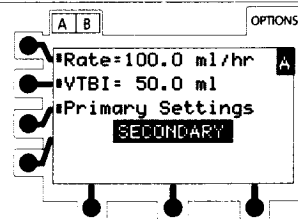

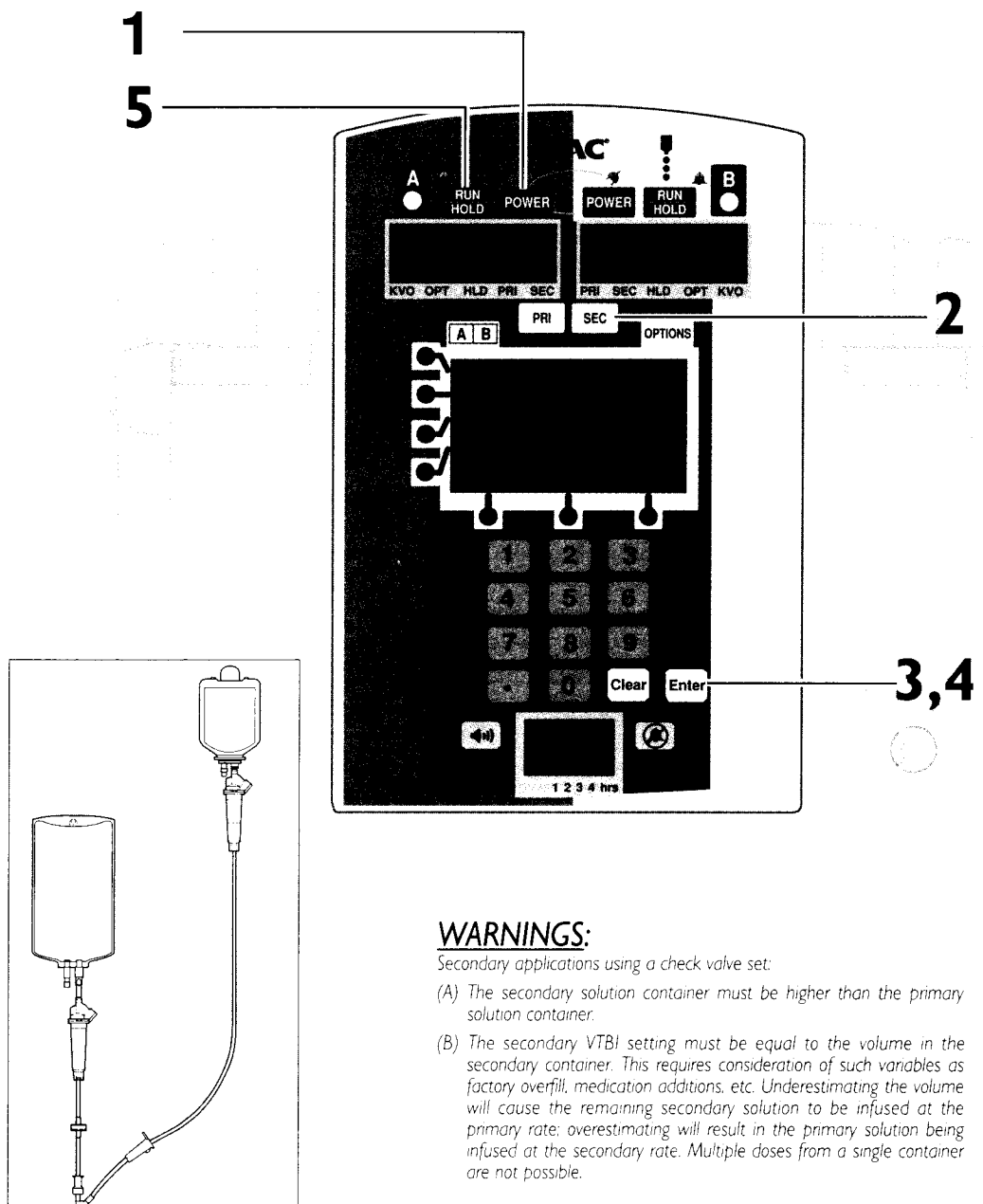

WARNINGS:

Secondary applications using a check valve set:

- (A) The secondary solution container must be higher than the primary solution container.
- (B) The secondary VTBI setting must be equal to the volume in the secondary container. This requires consideration of such variables as factory overflow, medication additions, etc. Underestimating the volume will cause the remaining secondary solution to be infused at the primary rate; overestimating will result in the primary solution being infused at the secondary rate. Multiple doses from a single container are not possible.

Making Changes During Secondary Mode

Select desired channel, as necessary. The channel does not need to be on hold to change settings for Rate or VTBI.

- 1** Press soft key for value you want to change.
 - Current value will be highlighted.

To Change Secondary Infusion Rate:

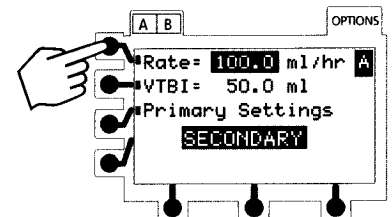

To Change Secondary Volume To Be Infused:

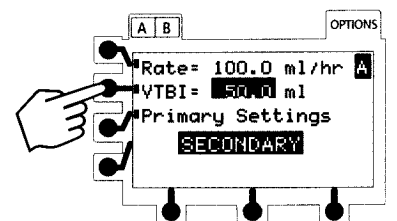

- 2** Use numeric key pad to enter new value.

- 3** Press **Enter** to accept new value(s).

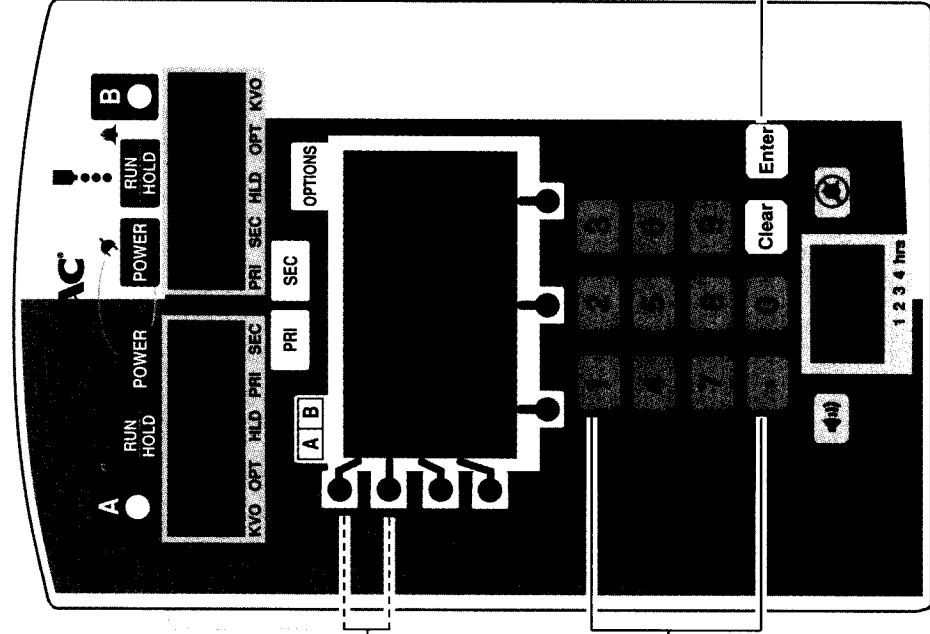

To View or Change Primary Settings During Secondary Mode

Select desired channel, as necessary

1 Press **Primary Settings**.

- Primary rate (**Pri Rate**), primary volume to be infused (**Pri VTBI**) and total volume infused (**Total VI**) will be displayed.
- The display will return to the normal secondary page after 6 seconds.

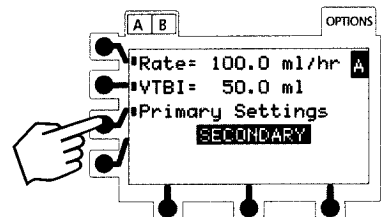

2 Press **Pri Rate**, **Pri VTBI**, or **Total VI** to:

- "freeze" the display
- highlight the value

To Change Primary Rate During Secondary Mode:

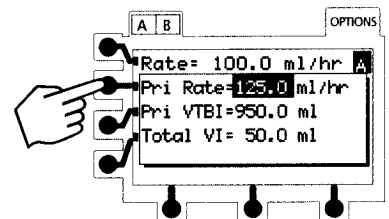

To Change Primary VTBI During Secondary Mode:

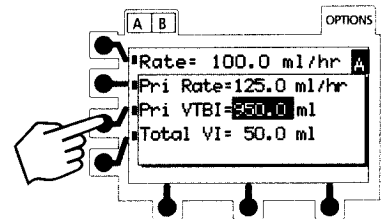

NOTE: If the flow sensor option is being used, VTBI can be turned OFF by selecting VTBI, then pressing **Clear**.

OR

Primary VTBI can be deleted from the primary mode setup page (Programmable Features)

To Clear Total Volume Infused During Secondary Mode:

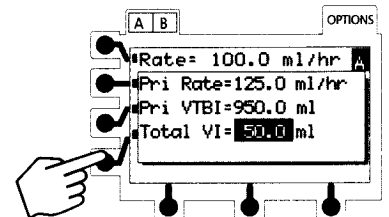

3 Use the numeric key pad to enter new value.

OR

4 Press **Clear** or 0 (zero key) to reset volume infused to 0.0.

5 Press **Enter** to accept new value(s).

- The display will return to the normal secondary page after 6 seconds.

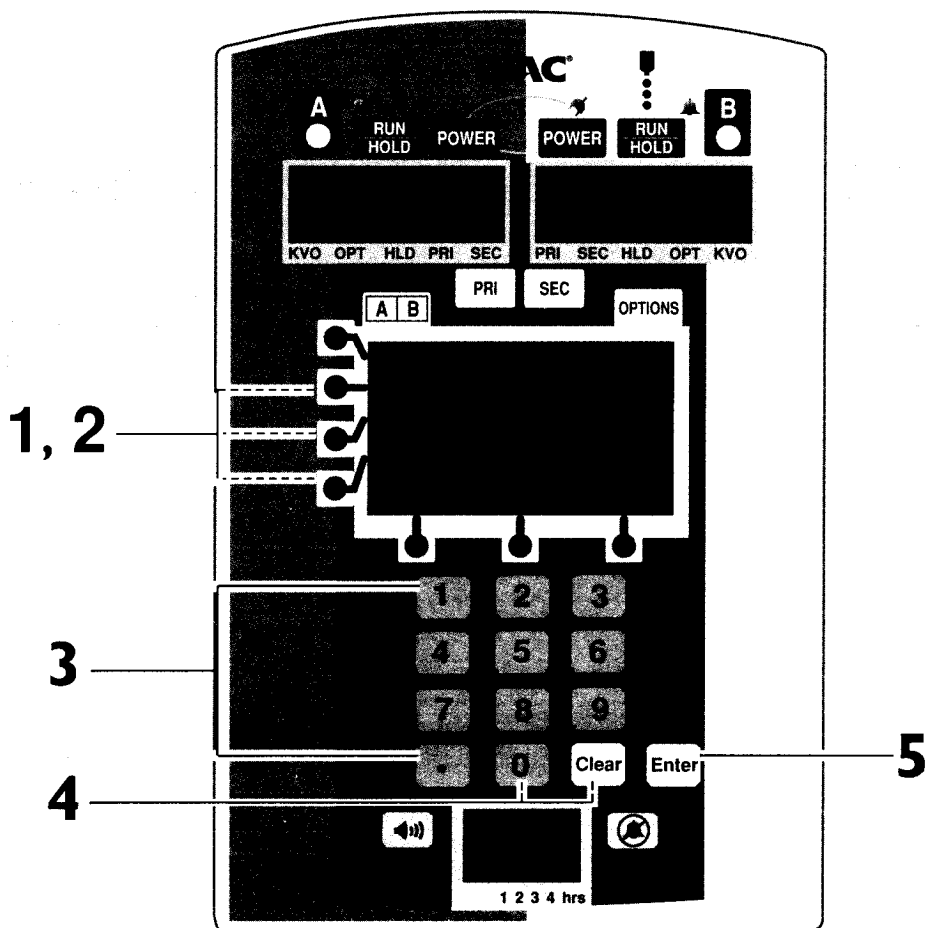

PRIMARY CHANGES SECONDARY

Unloading the Set

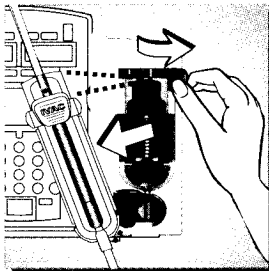
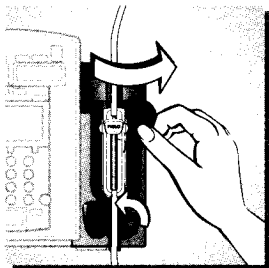

- 1 Place the channel on hold.
 - 2 Open the latch.
 - The AccuSlide Flow Regulator clamp will automatically close to prevent accidental free-flow.
 - 3 Press lightly against the open latch.
 - The set will be ejected from the pump.
- WARNING:** Verify AccuSlide Flow Regulator clamp is closed when set is removed from pump.
- 4 Close the latch(es) whenever the pump is not in use.

To Turn Pump Off

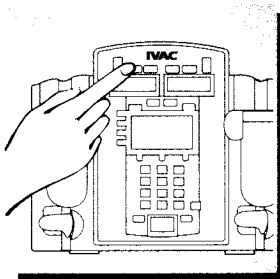

- Press and hold the channel's **POWER** until display turns off.
- Current settings will be retained in memory.

Alarms, Alerts and Prompts

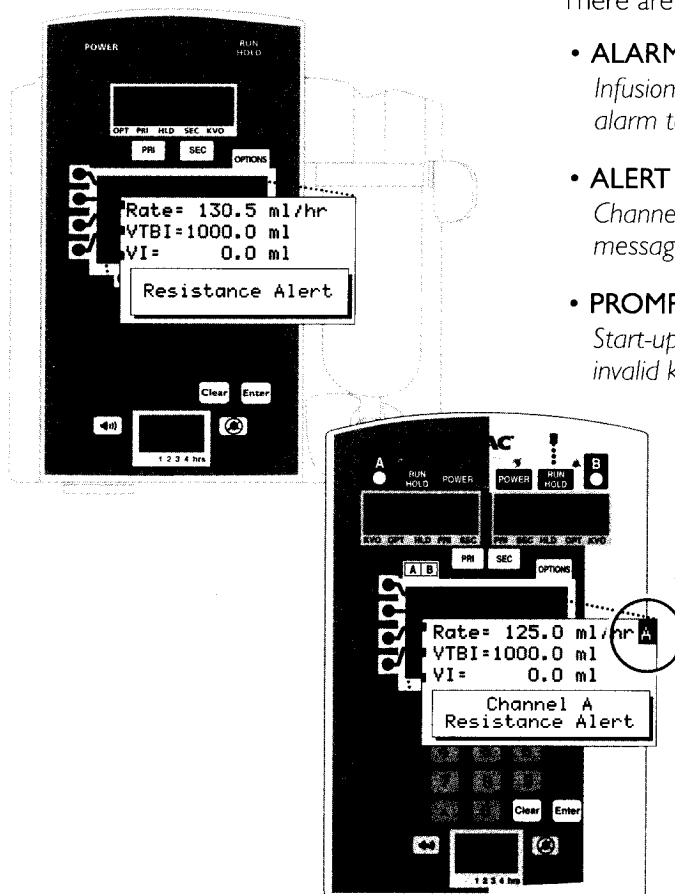

There are 3 types of displayed messages.

- **ALARM** — pump or channel problem
Infusion stops, accompanied by message (🔔) and alarm tone.
- **ALERT** — change in infusion status
Channel continues to operate, accompanied by message and alert tone.
- **PROMPT** — infusion status not changed
Start-up procedures were not completed or an invalid key was pressed.

NOTE: When using the Model 7200, some messages will also display "Channel A" or "Channel B" to indicate which channel is affected. Always verify the channel is selected before making any changes.

Messages are listed alphabetically, with a probable cause and suggested remedy next to each one. Use this section in conjunction with appropriate clinical practice or hospital procedure.

All Model 7100 and 7200 messages are represented. Model 7200 displays are used for illustration purposes.

MESSAGE

PROBABLE CAUSE

REMEDY

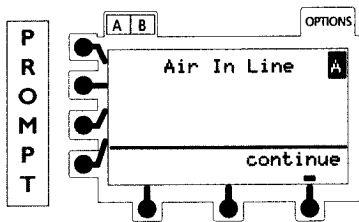

The air detector has detected air prior to starting the infusion.

Verify the set is loaded correctly. Prime and reload the set or remove the air. Press **continue**.

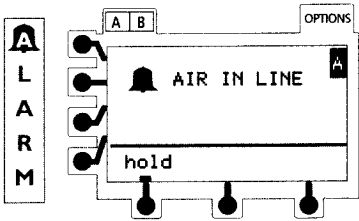

The air detector has detected an air bubble larger than its configured threshold.

The Air-in-Line Reset feature is off.

Press **hold** to place the channel on hold. Remove the air. Press to resume infusion.

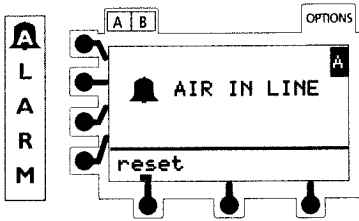

The air detector has detected an air bubble larger than its configured threshold.

The Air-in-Line Reset feature is on.

Evaluate the air in the set. Remove the air.

OR

If the air bubble is clinically non-significant, you may press **reset**, then press **run**, to resume the infusion.

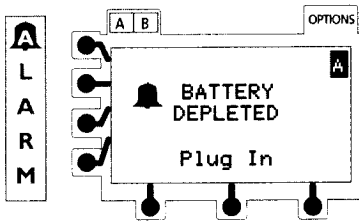

The battery is too low to operate the pump.

Plug the power cord into an AC outlet immediately. Press **run, hold**, or to resume infusion.

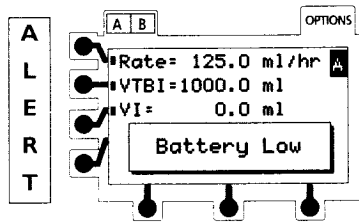

The battery has 30 minutes or less of charge remaining.

Plug the power cord into an AC outlet as soon as possible.

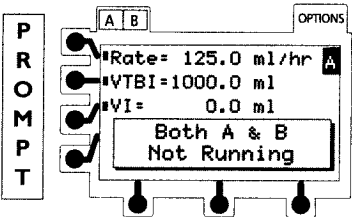
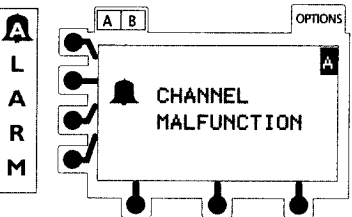
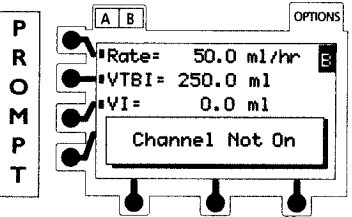
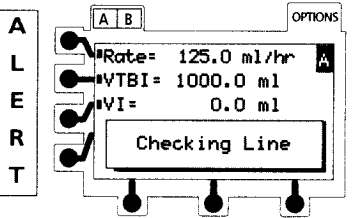
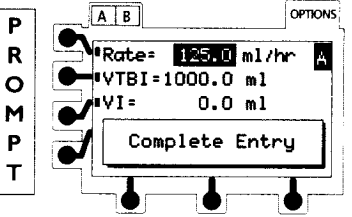
| MESSAGE | PROBABLE CAUSE | REMEDY |
|---|---|---|
|  | <p>The A B was pressed, but both channels are not infusing.</p> <p>Model 7200 only.</p> | <p>Both channels must be infusing for the split screen feature to operate.</p> |
|  | <p>Channel malfunction.</p> <p>Model 7200 only.</p> | <p>Turn the channel off, then on. If the problem persists, do not use the channel. Contact qualified service personnel.</p> |
|  | <p>The channel's RUN HOLD or A was pressed, but the channel is not on.</p> <p>Model 7200 only.</p> | <p>The channel must be turned on to view or change settings.</p> |
|  | <p>Flow has been obstructed between the pump and the patient.</p> <p>PF AutoRestartPlus feature is on.</p> | <p>Channel will continue delivery if occlusion is relieved within 40 seconds. Check the administration set for probable cause (kinked tubing, clogged filter, etc.)</p> |
|  | <p>Enter was not pressed to accept a new value.</p> | <p>Press Enter.</p> |

MESSAGE

PROBABLE CAUSE

REMEDY

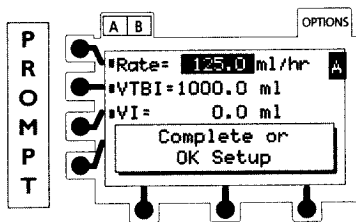

RUN HOLD was pressed before the setup was completed or ok'd.

Complete the setup. Press **ok**.

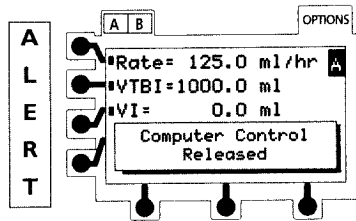

Control of the pump has been released from the host computer.

Re-establish or discontinue computer control mode, as appropriate.

PF Computer Link feature is in control mode.

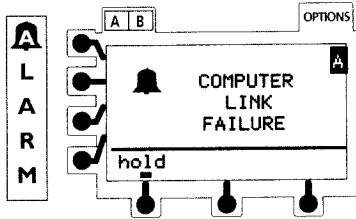

The RS 232 connection to the computer was disrupted.

Check the RS 232 connections.

PF Computer Link feature is in control or monitor mode.

Clearing this alarm automatically puts the pump in monitor mode. Re-establish infusion. Re-establish computer control mode, if appropriate.

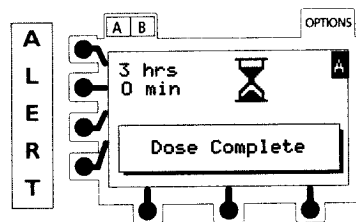

A dose delivery has just been completed.

The channel will automatically switch to the timer.

If the Dose Complete Alert Option is activated, press **cancel alert** to silence the audio signal.

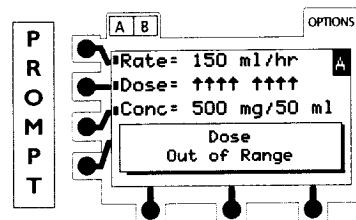

The calculated dose is outside the allowable range.

Verify and re-enter settings.

MESSAGE

PROBABLE CAUSE

REMEDY

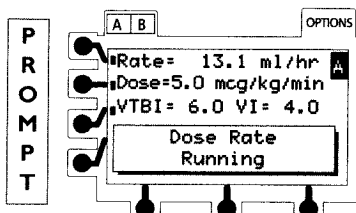

The **PRI** or **SEC** was pressed while running in the Dose Rate program.

The channel must be on hold to change modes.

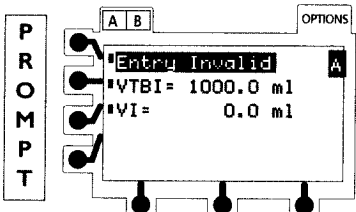

An invalid value was entered during programming.

Press **Clear** or 0 to clear the entry. Enter appropriate value.

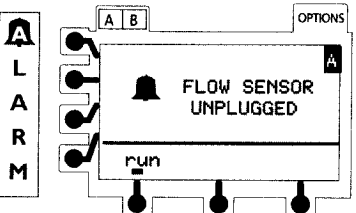

The flow sensor is unplugged from the back of the instrument.

Plug flow sensor into the flow sensor receptacle.

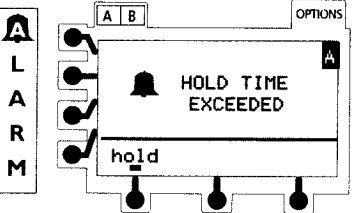

The channel has been on hold for five minutes and no keys have been pressed.

Press **hold** to return to the hold mode.

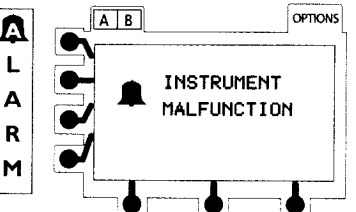

Instrument malfunction. Model 7200: Neither channel is functional.

Turn the pump off, then on. If the problem persists, do not use the pump. Contact qualified service personnel.

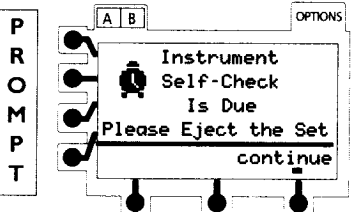

Instrument/channel has not performed self-check for one month.

Eject the set. Wait five seconds, then reload the set.

| | MESSAGE | PROBABLE CAUSE | REMEDY |
|----------------------------|---------|---|---|
| P R O M P T | | The calculated rate is outside the allowable range. | Verify and re-enter settings. |
| A L A R M | | A key is stuck or was held down too long. | Release the key. Turn the pump off, then on. If the problem persists, do not use the pump. Contact qualified service personnel. |
| P R O M P T | | The latch is open. | Close the latch fully to the left. Press continue . |
| A L A R M | | The latch was opened during an infusion. | Check for proper set installation. Close the latch. Press run . |
| A L E R T | | The Loading Dose program has just been completed. | The channel will automatically switch to primary infusion. |
| P R O M P T | | The PRI or SEC was pressed while running in the Loading Dose program. | The channel must be on hold to change modes. |

MESSAGE

PROBABLE CAUSE

REMEDY

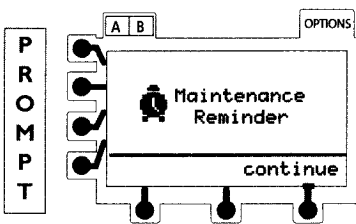

The periodic maintenance interval has elapsed.

The Maintenance Reminder feature is on.

Notify your Biomedical Engineering department. If desired, press **continue** to temporarily bypass the reminder.

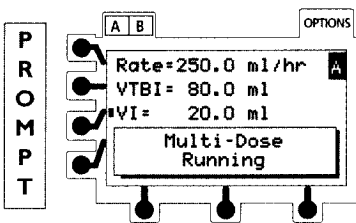

The **PRI** or **SEC** was pressed while running in the Multi-Dose program.

The channel must be on hold to change modes.

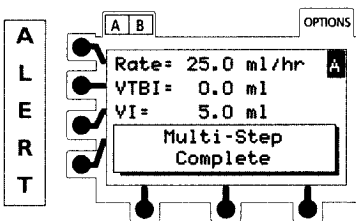

Multi-Step program has just been completed.

The channel will automatically switch to KVO infusion.

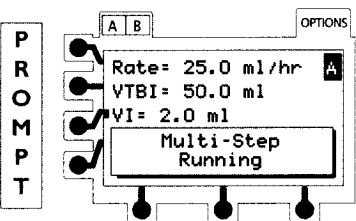

The **PRI** or **SEC** was pressed while running in the Multi-Step program.

The channel must be on hold to change modes.

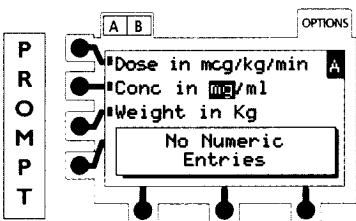

A numeric key was pressed during non-numeric selection.

Press **ok** to approve all displayed information.

OR

Press to view available unit selections.

MESSAGE

PROBABLE CAUSE

REMEDY

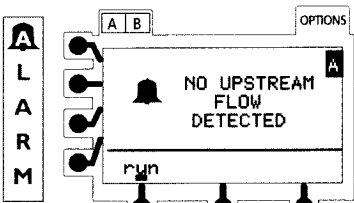

Flow has been obstructed between the container and the pump.

Only when using flow sensor.

Check to see if the container is empty, the flow sensor is mis-positioned or clouded, or if the set regulating clamp is closed. Verify correct set connections and open fluid path. Press **run** to restart the infusion.

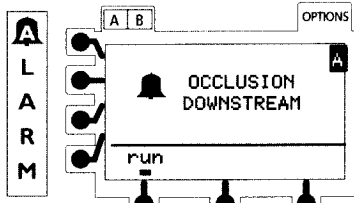

Flow has been obstructed between the pump and the patient.

Check the administration set for probable cause (kinked tubing, clogged filter, etc.) Press **run** to restart the infusion.

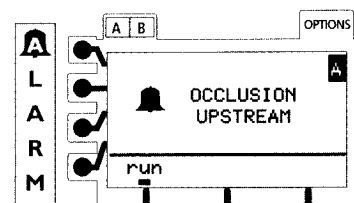

Flow has been obstructed between the fluid container and the pump.

Check the administration set for probable cause (kinked tubing, closed clamp, etc.) Press **run** to restart the infusion.

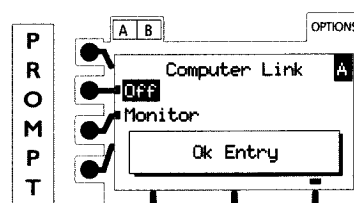

User has attempted to go to another page before pressing ok.

Verify selection and press **ok**.

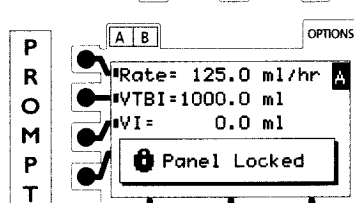

A key was pressed.

 The Panel Lock feature is on.

Turn panel lock off to access panel controls. Panel lock key is located behind the handle.

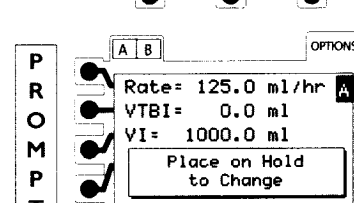

A key was pressed during KVO.

The channel must be on hold to make changes.

| | MESSAGE | PROBABLE CAUSE | REMEDY |
|----------------------------|---------|---|---|
| P R O M P T | | <p>POWER was pressed.</p> | <p>Press and hold POWER until the display turns off.</p> |
| A L A R M | | <p>The pump detected flow from the primary container during secondary infusion.</p> <p>Only when using flow sensor.</p> | <p>The secondary container must not be underfilled and the set regulating clamp must be open. Verify set connections are correct then press run to restart the infusion.</p> |
| P R O M P T | | <p>The PRI or SEC was pressed while the channel was running in the primary mode.</p> | <p>The channel must be on hold to change modes.</p> |
| P R O M P T | | <p>The pump detected a memory failure. Existing settings have been erased.</p> | <p>Press continue and re-enter all infusion settings.</p> <p>Note: Programmable features are not affected.</p> |
| P R O M P T | | <p>The calculated rate is outside the allowable range.</p> | <p>Verify and re-enter settings.</p> |
| A L E R T | | <p>IV line resistance has reached the preset level.</p> <p> Resistance Alert feature is on.</p> | <p>Check the downstream line and the site. Raise the resistance alert level, if appropriate.</p> |

MESSAGE

PROBABLE CAUSE

REMEDY

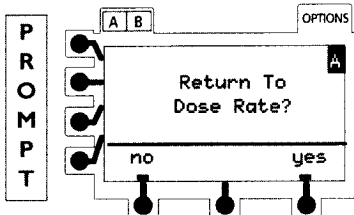

The channel was turned off during a Dose Rate program within the last six hours.

Press **yes** to return to the Dose Rate program or press **no** to return to the primary setup page.

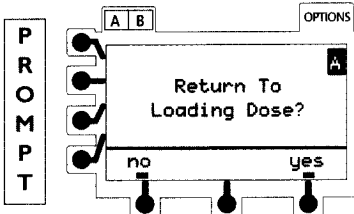

The channel was turned off during a Loading Dose program within the last six hours.

Press **yes** to return to the Loading Dose program or press **no** to return to the primary setup page.

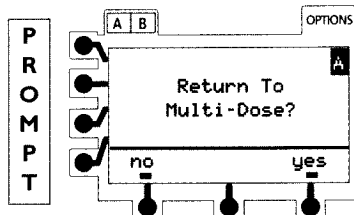

The channel was turned off during a Multi-Dose program within the last six hours.

Press **yes** to return to the Multi-Dose program or press **no** to return to the primary setup page.

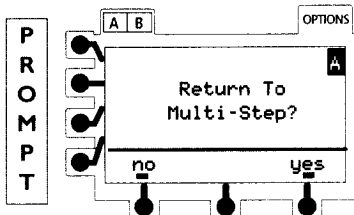

The channel was turned off during a Multi-Step program within the last six hours.

Press **yes** to return to the Multi-Step program or press **no** to return to the primary setup page.

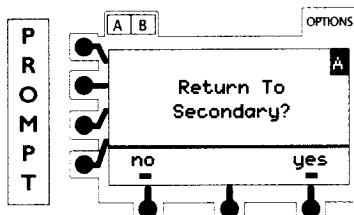

The channel was turned off during a secondary infusion within the last six hours.

Press **yes** to return to secondary mode or press **no** to return to the primary setup page.

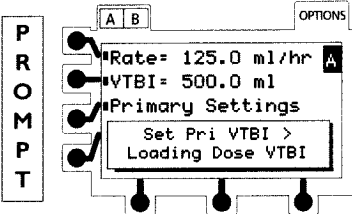
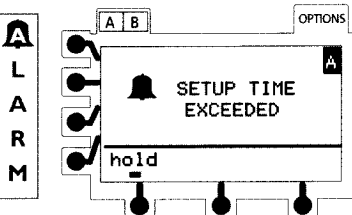
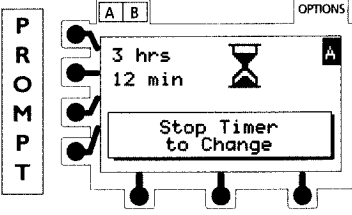
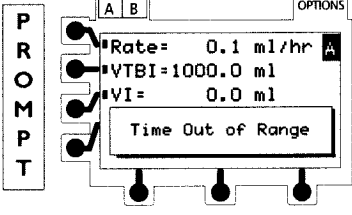
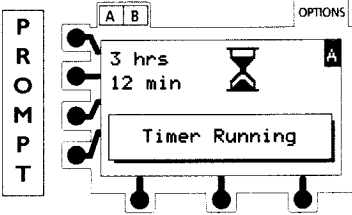
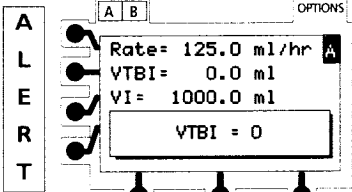

| | MESSAGE | PROBABLE CAUSE | REMEDY |
|----------------------------|--|---|--|
| P R O M P T | <p>Rate= 100.0 ml/hr VTBI= 50.0 ml Primary Settings Sec Running</p> | The PRI or SEC was pressed while the channel was running in the secondary mode. | The channel must be on hold to change modes. |
| A L E R T | <p>Rate= 125.0 ml/hr VTBI=1000.0 ml VI= 50.0 ml Secondary Complete</p> | Secondary delivery has just been completed. | The channel will automatically switch to primary infusion. |
| P R O M P T | <p>Pri Rate=125.0 Rate=130.5 VTBI= VTBI= Select Channel</p> | Channel has not been selected. Model 7200 only. | Press A or B . |
| P R O M P T | <p>Set Out continue</p> | The AccuSlide Flow Regulator segment is not installed correctly. | Re-install the AccuSlide Flow Regulator segment. Press continue . |
| A L A R M | <p>SET OUT run</p> | Set has been removed during an infusion. | Re-install set. Press run . |
| P R O M P T | <p>Rate= 125.0 ml/hr VTBI= 0.0 ml VI= 0.0 ml Set Pri VTBI</p> | A primary VTBI was not programmed. | Enter a primary VTBI. |

| MESSAGE | PROBABLE CAUSE | REMEDY |
|---|--|---|
|  | <p>The Loading Dose VTBI entered is greater than the primary VTBI.</p> | <p>Raise the primary VTBI or lower the Loading Dose VTBI, as appropriate.</p> |
|  | <p>The pump has been turned on, but no keys have been pressed for 10 minutes.</p> | <p>Press hold to return to the hold mode. The instrument will turn off if left in alarm more than 5 minutes. If an audio alarm remains on, turn the pump on, then off again.</p> |
|  | <p>An invalid key was pressed while the timer was running in the Multi-Dose program.</p> | <p>Press stop timer to make changes.</p> |
|  | <p>The total time entered in the program exceeded 99 hours, 59 minutes.</p> | <p>Verify and re-enter settings.</p> |
|  | <p>The PRI or SEC was pressed while the timer was running in the Multi-Dose program.</p> | <p>Press stop timer to make changes.</p> |
|  | <p>VTBI has counted down to zero. The channel is in KVO mode.</p> | <p>Put the channel on hold to re-enter a primary VTBI. Change the solution container, if necessary. OR Terminate the infusion.</p> |

FEATURES AND OPTIONS

Battery Management System

The Battery Management System incorporates features which enhance battery maintenance in order to maximize the life of the battery, reduce associated costs, and increase availability of pumps. The system provides:

- A green  that lights when the pump is plugged in.
- A yellow  that flashes when the pump is operating on battery power.
- Automatic battery power if the pump is unplugged or in the event of a power failure.
- A low battery alert.

Maximum battery capacity, as well as gauge accuracy, is reached after several charge/discharge cycles. For best results, fully charge and discharge the battery 2-3 times before putting the pump into service.

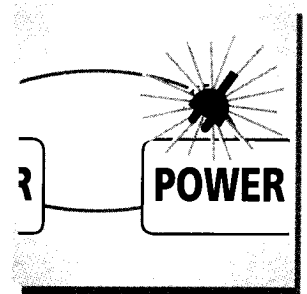

Battery Power Gauge

The gauge indicates approximate battery time remaining in 15 minute increments under current conditions. It is located in the lower display and is on, when the pump is on. Always check the battery time available before operating the pump on battery power.

NOTE: Gauge accuracy will be affected by charge cycles.

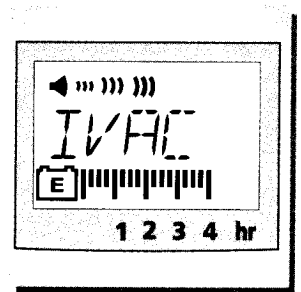

Automatic Recharge

The battery automatically recharges whenever the pump is plugged into an AC line.

All batteries gradually lose their capacity to hold a charge.

Qualified service personnel can replace the battery when charging capacity gets too low.

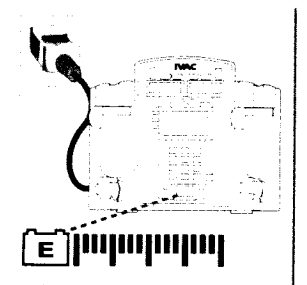

Nurse Call

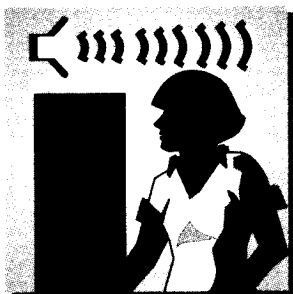

If your pump is equipped with the optional nurse call feature, alarms and some alerts from the pump will be relayed to the hospital's existing nurse call system. No operating features of the pump are changed. The pump will alarm with or without the nurse call installed.

To activate the nurse call feature:

- 1 Plug the nurse call cable into the  on the instrument back panel.

NOTE: A false remote alarm may occur if the nurse call plug is not properly inserted.

- 2 Press channel **POWER**.
 - The instrument will beep briefly to signal proper operation.
- 3 Plug the nurse call cable into the nurse call system.
- 4 Operate the pump as described in this *Directions For Use*.
 - All alarms and some alerts will activate the nurse call system. The following alerts will not activate the nurse call system:

Checking Line
Dose Complete
Load Dose Complete
Multi-Step Complete
Secondary Complete

If an alarm occurs:



- 1 Go to the pump.
- 2 Use the ALARMS, ALERTS AND PROMPTS section of this manual to determine the cause and appropriate corrective action.
- 3 Reset your nurse call system, as required.

NOTE: Disconnecting the nurse call cable from the wall or turning off the pump will activate the nurse call system. Disconnecting the nurse call cable from the pump will not activate the nurse call system.

Panel Lock



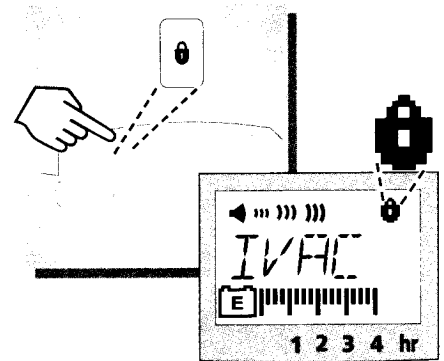

The panel lock feature helps prevent unauthorized changes of any pump settings, including turning the pump off. The panel lock key, , is located behind the handle.

To turn on the panel lock feature:

Press and hold the  until the  appears in the lower display.



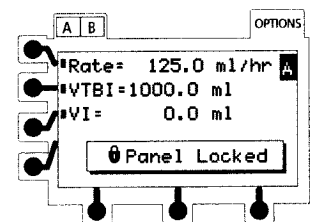

If panel lock feature is on:

- , , and  keys can be used for viewing settings (7200 only).
-  **Panel Locked** appears in the main display if any other key is pressed.



To turn off the panel lock feature:

Press and hold the  until the  in the lower display disappears.

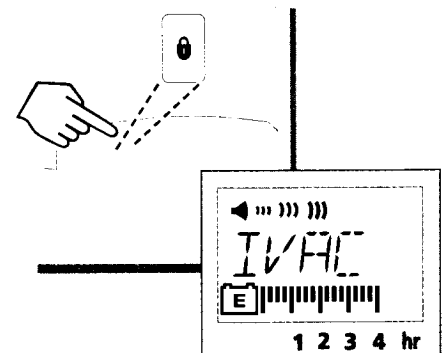

NOTE: To make changes or respond to an alarm, the panel lock must be turned off.

Pole Clamp

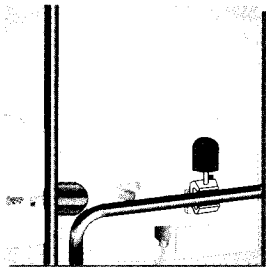

The uniquely designed pole clamp adapts to a wide variety of surfaces (e.g., poles, bedrails) to provide greater versatility and to simplify transports. It features:

- 360° rotation in 90° increments

NOTE: The pump must remain in upright position.

- Ergonomically designed knob
- Accommodates diameters from 15 to 35 millimeters

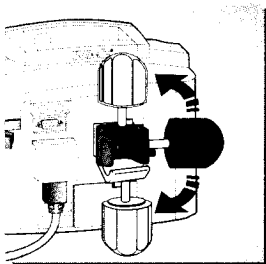
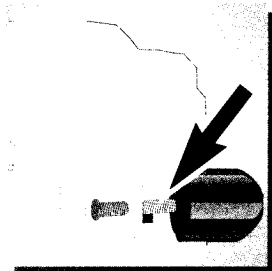

To change the pole clamp orientation:

- 1** Press and hold the rotation lever.
- 2** Reposition the clamp.
- 3** Release the lever at the desired position.

Air-In-Line Reset

The Air-in-Line Reset feature allows the clinician to respond to an air-in-line alarm, assess the clinical significance of the air, and choose whether or not to continue the infusion without removing the air bubble.

The Air-in-Line Reset feature may be turned on or off by qualified service personnel.

If Air-in-Line Reset feature is off:

- 1 Press **hold** to place the channel on hold.
- 2 Remove the air.
- 3 Press  to resume infusion.

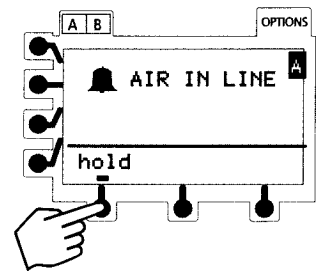

If Air-in-Line Reset feature is on:

- 1 Evaluate the air in the set.
- 2 Remove the air,

OR

- 1 If the air bubble is clinically non-significant, press **reset**.
- 2 Press **run**.
 - The channel will resume the programmed infusion.
 - The detected bubble is allowed to pass by the detector.
 - A new bubble will again trigger the alarm.

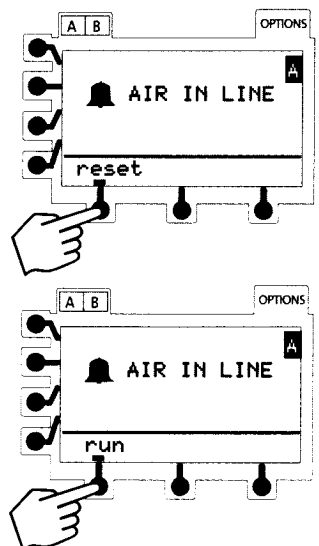

Dynamic Monitoring System

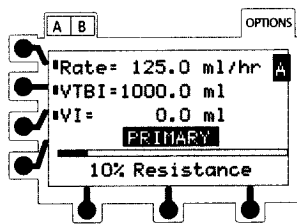

The Dynamic Monitoring system evaluates downstream line pressure and fluid flow to determine flow resistance. This system gives the clinician quick and accurate notice of full and partial occlusions. Components of this system are:

- **Monitoring Options**, to provide IV line/site monitoring for resistance, high resistance and pressure.
- **AutoRestartPlus feature**, which allows the pump to automatically continue operation if an occlusion is cleared within the self-check period.
- **Resistance Alert**, to provide an early warning of increases in flow resistance.
- **Resistance Trend Graph**, to display flow resistance over time.

Monitoring Options

IV lines, catheters and applications create various levels of resistance to flow. Three monitoring options are available depending on clinical need.

- **Resistance** — designed to monitor IV line/site resistance in normal applications.
- **High Resistance** — designed for higher flow resistance encountered in applications such as epidural infusions and infusions through long, narrow catheters (PICCS, etc.)
- **Pressure Only** — monitors site by pressure.

To select one of the three options:

- 1 Press **OPTIONS**.
 - The Options page will appear.
- 2 Press **Monitoring Options**.
 - The Monitoring Options page will appear.
- 3 Press **Resistance** or **High Resistance** or **Pressure Only**.
- 4 Press **ok**.
 - The display will automatically return to the normal operating page.

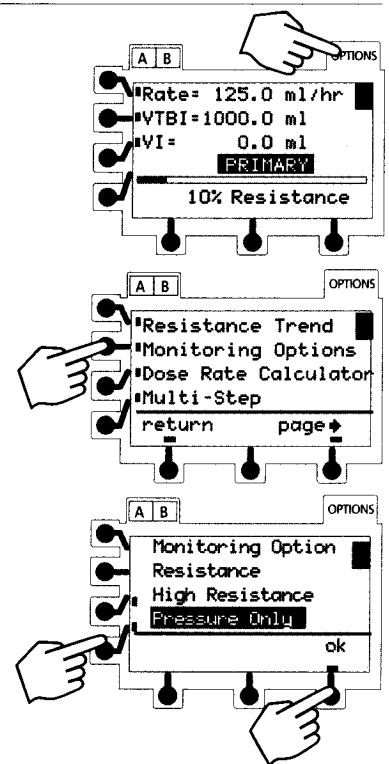

If Resistance Option is selected:

The Resistance message is displayed below the bar graph resistance display. Resistance Option will remain in effect until:

- High Resistance or Pressure Only is selected from the Monitoring Options page (as above),
- OR**
- The channel is turned off.
 - The channel will return to the default option set by qualified service personnel.

If High Resistance Option is selected:

The High Resistance message is displayed below the bar graph resistance display. High Resistance Option will remain in effect until:

- Resistance or Pressure Only is selected from the Monitoring Options page (as above),
- OR**
- The channel is turned off.
 - The channel will return to the default option set by qualified service personnel.

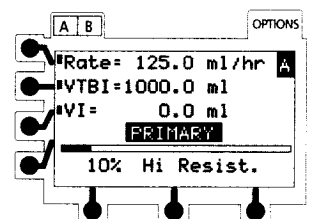
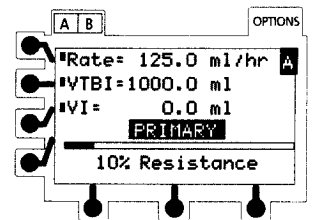

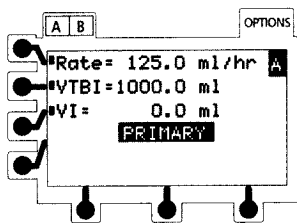

If Pressure Only is selected:

Bar graph resistance will not be displayed and there will be no message. The Pressure Only Option will remain in effect until:

- Resistance or High Resistance is selected from the Monitoring Options page (as above),

OR

- The channel is turned off.
 - The channel will return to the default option set by qualified service personnel.

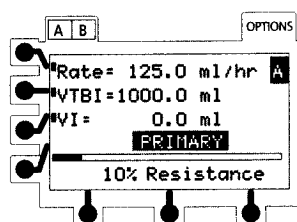

The pump displays downstream resistance and high resistance with a bar graph and numeric value while infusing. Typical resistance values may be in the range of 0-30%, depending on filters, solution viscosity, catheter diameter and length, etc. Values may be higher for partial occlusions, positional sites, etc.

100% Resistance indicates a complete occlusion.

- If the **AutoRestartPlus feature is on**, the pump will notify the clinician with a **Checking Line** message and alert tone. See AutoRestartPlus section for further details.
- If the **AutoRestartPlus feature is off**, the pump will notify the clinician with an **OCCLUSION DOWNSTREAM** alarm.

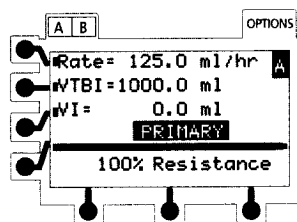

The Resistance and High Resistance displays may be turned on or off by qualified service personnel.

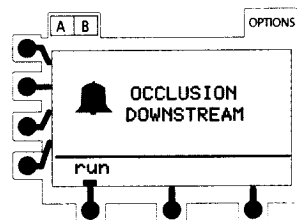

AutoRestartPlus

The AutoRestartPlus feature provides the ability to automatically continue an infusion if a downstream occlusion is cleared during the "self-check" period.

For example, if patient movement occludes the tubing, the resistance display will show 100%.

When resistance reaches 100%, the pump will notify the clinician with a **Checking Line** message and alert tone. The pump will continue to monitor the IV line/site for changes in resistance during the 40 second self-check period.

- If the resistance drops below 100% during this self-check period, the channel will continue delivery without clinician intervention.
- If the resistance in the IV line/site does not fall below 100% during this self-check period, the pump will notify the clinician with an **OCCUSION DOWNSTREAM** alarm.

Qualified service personnel can turn this feature off, or program it to restart from 1 to 9 times. When the programmed limit is reached, the channel goes directly into an Occlusion Downstream alarm if resistance reaches 100%. The counter is reset when  is pressed.

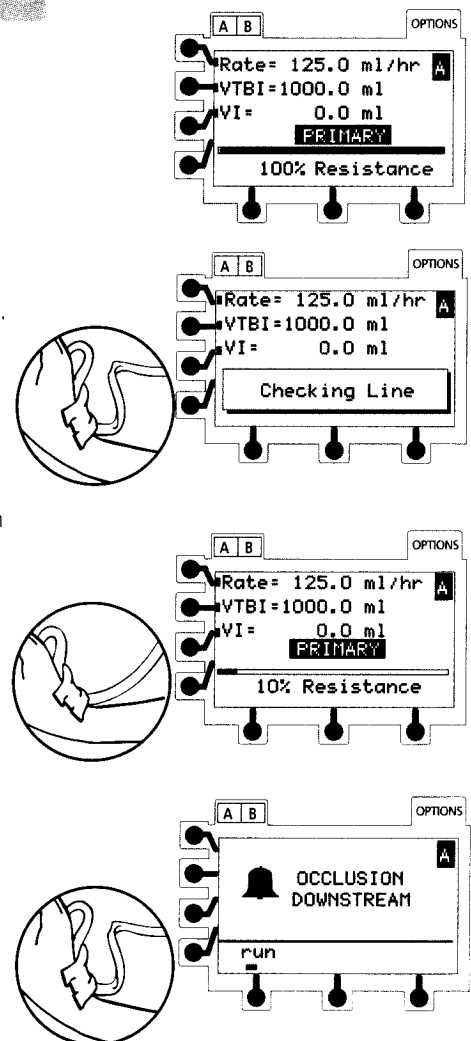



Resistance Alert

The Resistance Alert provides an early warning of changes in the resistance of the IV line/site. The Resistance Alert marker can be set from 5 to 100% in 5% increments.

Qualified service personnel can turn the alert feature on or off and set a default alert level.

To set the alert marker:

Press either  or  soft key to display the present alert level value.

- Each additional press of either arrow key will move the alert marker 5% in the corresponding direction, and increase or decrease the displayed numeric alert level.

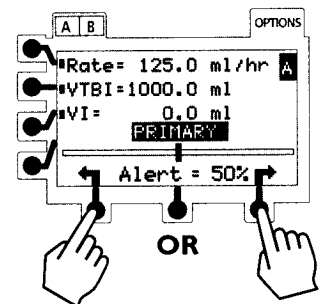

If resistance exceeds the alert marker:

The pump will notify the clinician with a **Resistance Alert** message and alert tone.

The message and tone will continue until:

- Resistance of the IV line/site falls below the alert marker;
- OR**
- The Resistance Alert marker is increased by the clinician;
- OR**
- Resistance rises to 100% and an **OCCCLUSION DOWNSTREAM** alarm occurs.

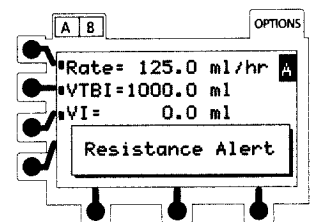

Resistance Trend Graph

The resistance trend graph displays flow resistance over time. Trend graphs of 15 minutes, 1 hour, 4 hours, and 12 hours are available during normal operation.

Qualified service personnel can turn this feature off or on.

To View Resistance Trend Graphs:

Model 7200 NOTES: (1) Select desired channel, as necessary. (2) The graph is not available when the split screen is displayed.

- 1 Press **OPTIONS**.
 - The Options page will appear:

- 2 Press **Resistance Trend**.
 - A trend graph will appear:

- 3 Press **time** to change the graph time frame.
 - A dashed horizontal line represents the current optional resistance alert level.
 - Gaps in the graph indicate non-infusing conditions, e.g. turned off, on hold, in alarm, etc.

NOTE: When viewing Resistance Trend Graphs in High Resistance or Pressure only modes, Hi Resist. will be displayed under the graph.

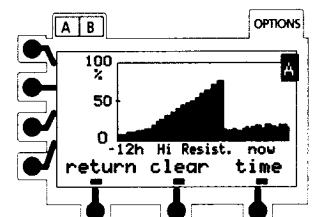
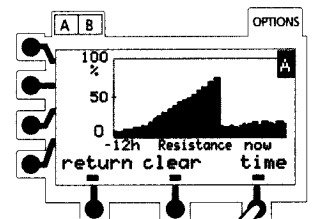
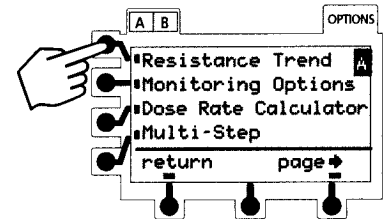
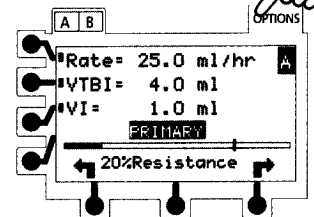
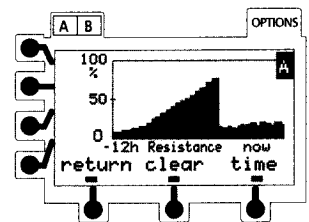

To Clear the Graphs:

1 Press **clear** to clear graphed data.

2 Press **ok**.

All data will then be cleared from the graphs.

NOTE: When changing from Resistance option to High Resistance or Pressure Only options, or from High Resistance or Pressure Only options to Resistance option, all trend data will automatically rescale. Changing between High Resistance and Pressure Only options will not effect data.

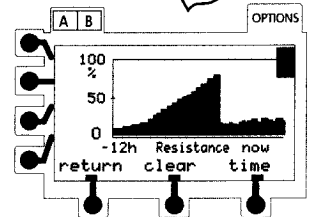
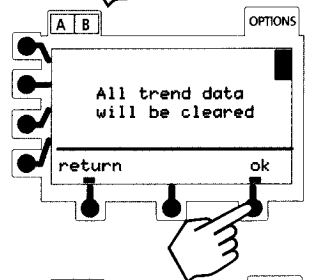
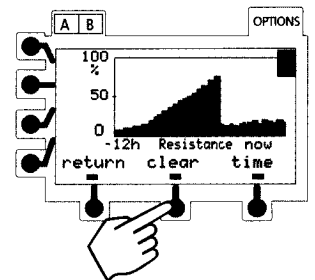

To Return to the Normal Operating Page:

1 Press **return**.

- The normal operating page will appear.
- Model 7200 Trend Graph will disappear after one minute and be replaced with split screen if both channels are infusing.

NOTE: Any of the following events will also turn off the trend graph.

- Pressing **A B** (7200 only)
- Pressing **RUN HOLD**
- An alarm

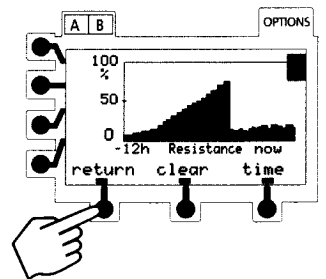

Flow Sensor

The optional Flow Sensor notifies users to empty containers and/or upstream occlusions. This feature is available on instruments that have ALARIS's Flow Sensor Kit installed by qualified service personnel.

NOTE: If flow sensor is not connected to the instrument, ensure protective plugs are installed at connector site to prevent entry of foreign material.

- 1** Plug Flow Sensor Model 180 into the receptacle on the back of the pump.
- 2** Attach the Flow Sensor to the flanges on the upper portion of the drip chamber:
 - When using the flow sensor, correct placement is essential for proper operation.
 - The upper surface of the flow sensor should be slightly below the drop-forming orifice, but above the level of fluid in the drip chamber.
- 3** Attach the flow sensor to the instrument handle when not in use.

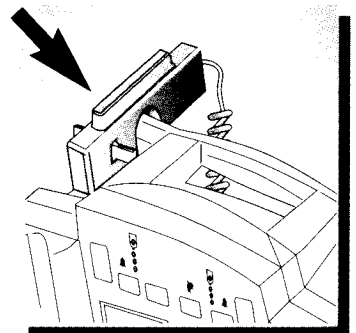
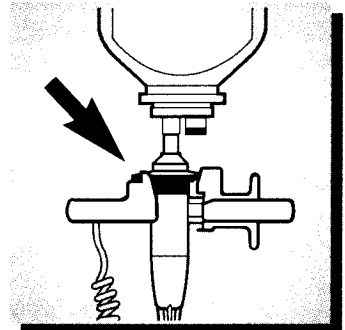
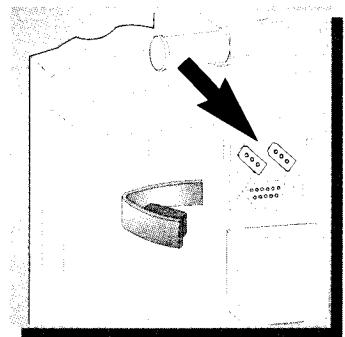

Drug-Specific Dose Rate Calculator (DRC)

This feature allows the clinician to select a drug name to calculate a volumetric rate or a dose rate for continuous drug infusions, and is based on parameters such as drug dosage, patient weight, concentration, etc. Once calculated, the pump will display the drug name selected on the infusion screen. Generic calculation (**Drug?**) is provided for drugs not available on the drug list.

At the end of the program, the channel will switch to the pre-set KVO rate or remain at the current rate, whichever is less.

Qualified service personnel can turn the Dose Rate Calculator feature on or off, and limit the list of drug names available and access to the generic calculator.

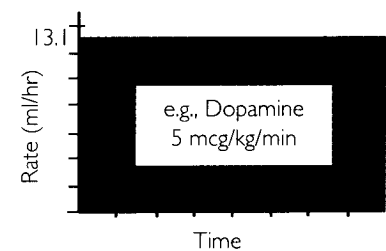

Facts About the DRC

- The patient weight, drug concentration, and diluent volume cannot be changed while infusing. Changes to any of these items while on hold will recalculate volumetric rate and maintain dose rate.
- All drug names are generic; they are abbreviated, when necessary. Model 7200 only: Drug names longer than ten letters are abbreviated if displayed on the split screen.
- The **Drug?** selection can be used for calculating when a particular drug name is not available on the drug list.
- When a drug amount is greater than 10,000 units (Un), a K is used to replace 000th. (e.g., 1,000,000 = 1,000K).
- DRC cannot be used in conjunction with secondary or other operating modes.

WARNING: *Ensure correct entry of all drug calculation infusion parameters. Consult the drug manufacturer's labeling for information concerning appropriate administration techniques and dosages.*

To Enter a New Program

Select desired channel, as necessary. The channel must be infusing in the primary mode, or on hold in the primary mode, secondary mode, or a Loading Dose program.

- 1 Press **OPTIONS**.
 - The Options page will appear.
- 2 Press **Dose Rate Calculator**.
 - The DOSE RATE MENU will appear.

- 3 Press **Enter New Program**.
 - A list of drug names will be displayed.

- 4 Press **+page** or **page+** to view additional drug name selections.

- 5 Press **Go To Extended List** (if shown) to view the full list of drug names.

If the desired drug name is listed, proceed to step 6.

If the desired drug name is not listed, proceed to step 10.

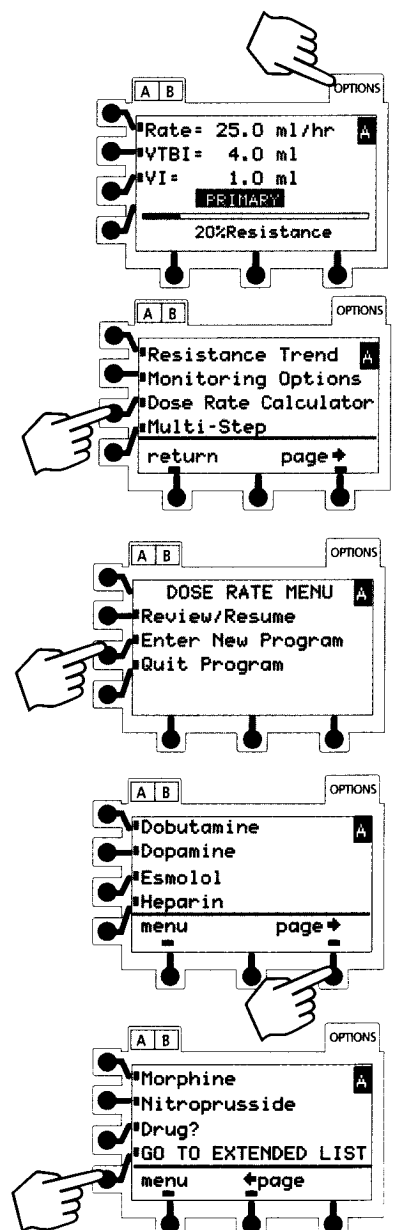

To Program the DRC With a Listed Drug Name

- 6** Press the soft key next to a drug name to select it.
- The appropriate dose units for the selected drug will be displayed. Dose units cannot be changed.

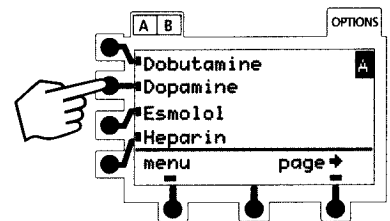

- 7** Press **ok** to approve all displayed information and advance to the first setup page.
- The dose rate will be highlighted.

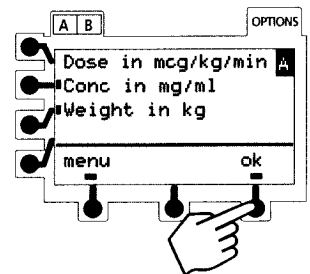

OR

- 8** To change concentration, height, or weight units:
Press the soft key next to a unit to select it.
- Weight or height unit selections will be displayed only if appropriate for the drug selected.

-  soft key will appear.

Press and release  to scroll through the units available.

Press **Enter** when the correct unit is displayed.

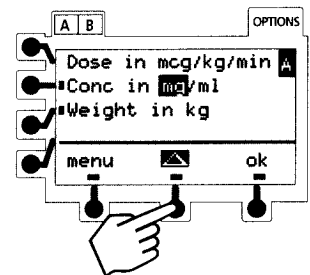

Concentration: mcg, mg, gm, U_n, or mEq
Weight: kg or lb
Height: cm or inches

- 9** Press **ok** to approve all displayed information and advance to the first setup page.
- The dose rate will be highlighted.

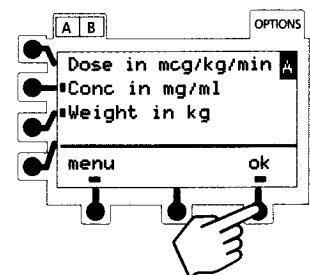

To calculate the volumetric rate, proceed to step 15

To calculate the dose rate, proceed to step 19 .

To Program the DRC When the Drug Name is Not Listed:

10 Press **Drug?** to use the generic dose calculation feature.

- Dose units will be displayed.
- The first segment will be highlighted.

Press **ok** at any time to approve all displayed information and advance to the first setup page.

11 If the dose unit is appropriate, press **Enter**.

OR

Press and release  to scroll through the units available.

Press **Enter** when the correct unit is displayed.

Repeat the steps for the other two dose unit segments.

- The concentration unit will be highlighted.

NOTE: *Day is defined as continuous delivery for 24 hours per day.

12 If the concentration unit is appropriate, press **Enter**.

OR

Press and release  to scroll through the units available.

Press **Enter** when the correct unit is displayed.

- Weight or height unit selections will be displayed only if appropriate for the dose unit selected.

13 If the weight or height unit is appropriate, press **Enter**.

OR

Press and release  to scroll through the units available.

Press **Enter** when the correct unit is displayed.

14 Press **ok** to approve all displayed information and advance to the first setup page.

- The dose rate will be highlighted.

To calculate the volumetric rate, proceed to step 15.

To calculate the dose rate, proceed to step 19

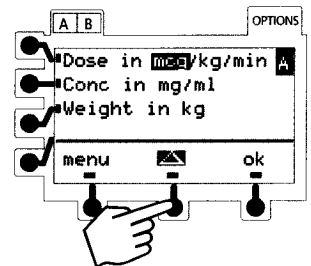
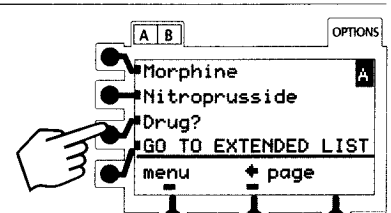

Dose Units: - mcg, mg, gm, Un, mUn, or mEq
- kg or m²
- min, hr, or day*

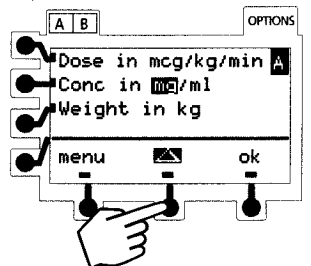

Concentration: mcg, mg, gm, Un, or mEq

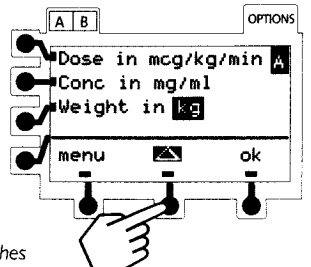

Weight: kg or lbs
Height: cm or inches

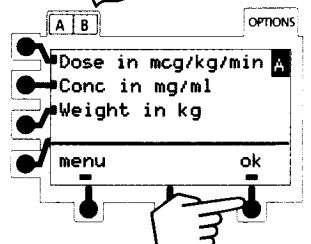

To Calculate Volumetric Rate

15 Use the numeric key pad to enter the dose rate

Press **Enter**.

- Concentration will be highlighted.

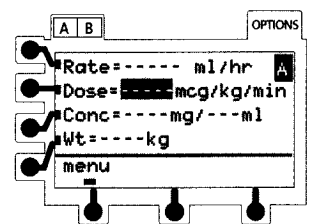

16 Use the numeric key pad to enter the concentration.

Press **Enter**.

- Diluent volume will be highlighted.

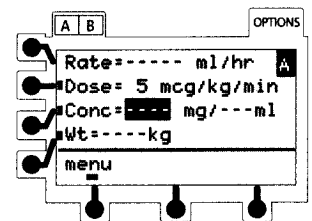

17 Use the numeric key pad to enter the diluent volume.

Press **Enter**.

- If applicable, the patient weight and/or height will be highlighted.

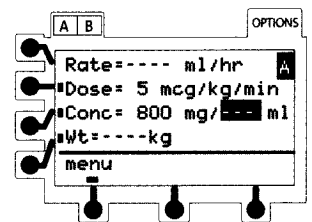

18 Use the numeric key pad to enter the weight and/or height.

Press **Enter**.

- The pump will automatically calculate and display the volumetric infusion rate in ml/hr.

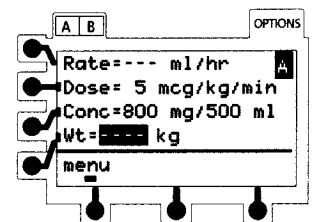

NOTE: ↑↑↑↑↑ or ↓↓↓↓↓ will appear if a calculated value is outside the display's range:

- Use the soft key to highlight the value you want to change.
- Use the numeric key pad to enter the value.
- Press **Enter** to accept the change.

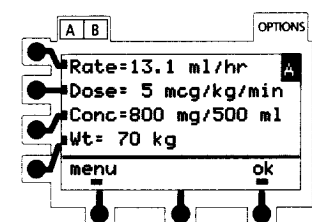

Proceed to step 19.

To Calculate Dose Rate

19 Press **Rate** to move the highlight to the volumetric rate. Use the numeric key pad to enter the rate.

Press **Enter**.

- Concentration will be highlighted.

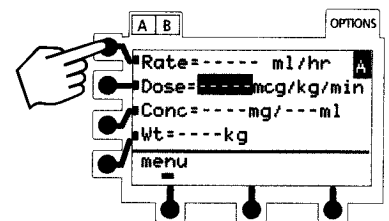

20 Use the numeric key pad to enter the concentration.

Press **Enter**.

- Diluent volume will be highlighted.

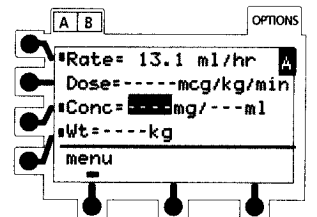

21 Use the numeric key pad to enter the diluent volume.

Press **Enter**.

- If applicable, the patient weight and/or height will be highlighted.

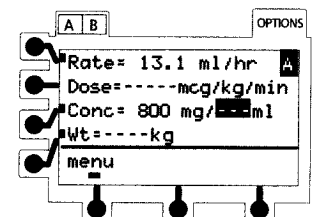

22 Use the numeric key pad to enter the weight and/or height.

Press **Enter**.

- The pump will automatically calculate and display the dose rate.

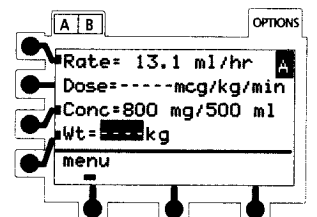

NOTE: ↑↑↑↑↑ or ↓↓↓↓↓ will appear if a calculated value is outside the display's range:

- Use the soft key to highlight the value you want to change.
- Use the numeric key pad to enter the value.
- Press **Enter** to accept the change.

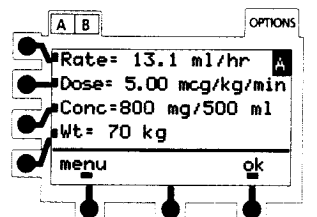

Proceed to step 23.

- 23** Verify all values and units. Press **ok** to approve all calculated and displayed information.

NOTE: If the channel is running in the primary mode while setting up the calculation, proceed to step 27.

- The next setup page will appear.
- The VTBI will be highlighted.

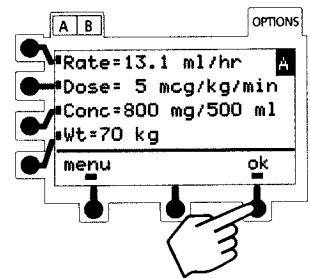

- 24** Use the numeric key pad to enter the VTBI value.

NOTE: If the flow sensor option is being used, Dose Rate VTBI can be turned OFF by selecting VTBI, then pressing **Clear**.

OR

Dose Rate VTBI can be deleted from VTBI/VI screen and main hold page (Programmable Features).

Press **Enter**.

- The VI will be highlighted.

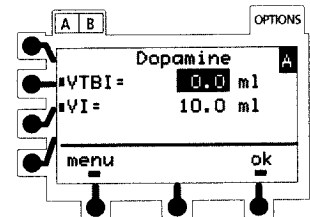

- 25** To clear the VI, press **Clear** or 0 (zero key).

Press **Enter**.

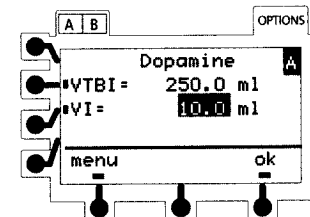

- 26** Press **ok** to approve all displayed information and advance to the main hold page.

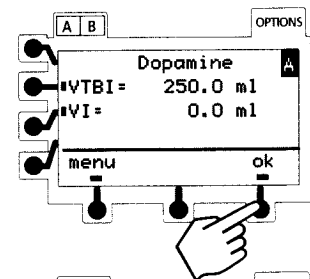

- 27** Press **RUN HOLD** or **run** to start the infusion.

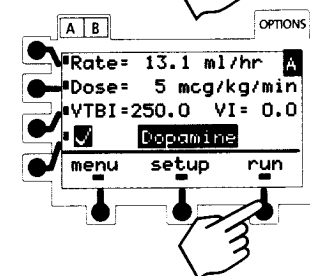

Making Changes During DRC Program

Select desired channel, as necessary. The channel does not need to be on hold to change volumetric rate, dose rate, or VTBI, to clear the VI, or to view more information.

NOTE: The pump will recalculate the program if the volumetric or dose rate, drug amount, diluent volume, weight, or height are changed.

To View More Information on the Dose Rate Setup

1 Press **Enter**.

- Additional Dose Rate setup information will be displayed for a short interval.

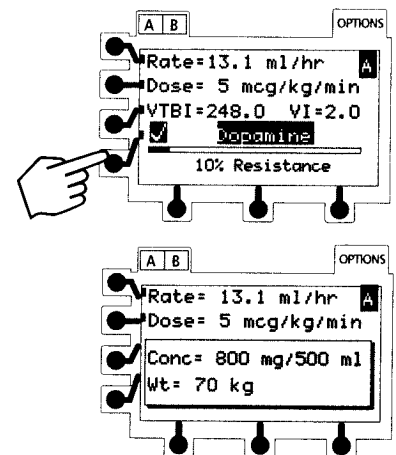

To Change the Volumetric Rate or Dose Rate

1 Press **Rate** or **Dose** to highlight the value.

2 Use the numeric key pad to enter the new value.

Press **Enter**.

- The new/recalculated value takes effect as soon as **Enter** is pressed.

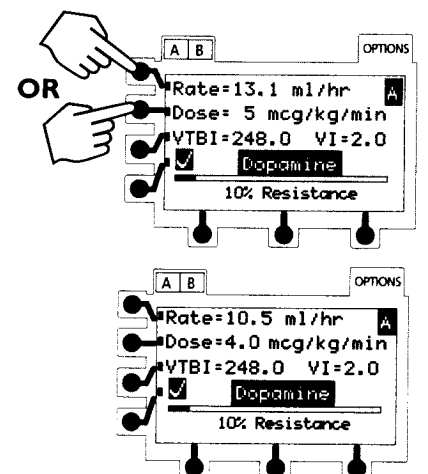

To Change the VTBI

1 Press **VTBI**.

- The VI will temporarily disappear, and VTBI will be highlighted.

2 Use the numeric key pad to enter the new value.

NOTE: If the flow sensor option is being used, Dose Rate VTBI can be turned OFF by selecting VTBI, then pressing

Clear

OR

Dose Rate VTBI can be deleted from VTBI/VI screen and main hold page (Programmable Features).

Press **Enter**.

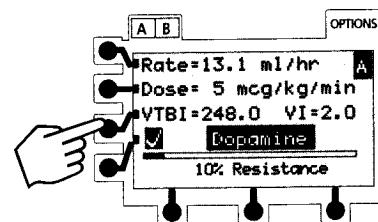

To Clear the VI

1 Press **VTBI** twice to move the highlight to **VI**; or press **VTBI**, then **Enter**.

- The VTBI will temporarily disappear, and VI will be highlighted.

2 Press **Clear** or 0 (zero key).

Press **Enter**.

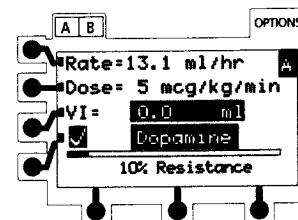
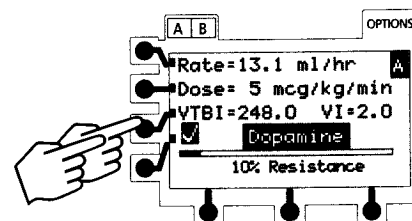

To Change the Weight or Height

NOTE: Any change to the weight or height will recalculate the volumetric rate.

- 1 Press **RUN HOLD** to place the channel on hold.
- 2 Press **setup** to return to the setup page.
- 3 Press **Wt** or **Ht**.
- 4 Use the numeric key pad to enter the new value.
Press **Enter**.
 - The recalculated volumetric rate will be displayed.
- 5 Press **ok** to approve all displayed information and advance to the main hold page.
- 6 Press **RUN HOLD** or **run** to resume the infusion.

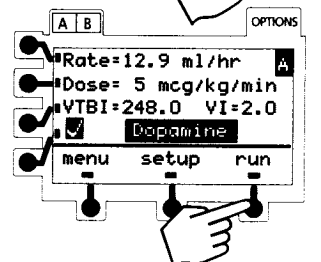
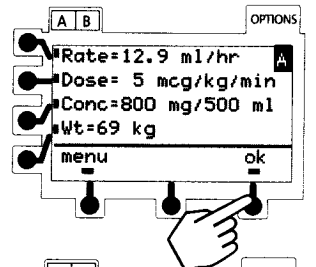
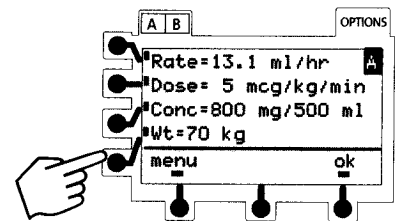
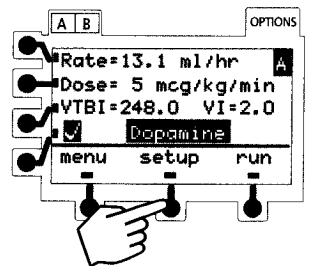

To Change the Concentration

NOTE: Any change to the drug amount or diluent volume will recalculate the volumetric rate.

1 Press **RUN HOLD** to place the channel on hold.

2 Press **setup** to return to the setup page.

3 Press **Conc** once to select the concentration value.

Press **Conc** twice to move highlight to the diluent value; or press **Conc**, then **Enter**.

4 Use the numeric key pad to enter the new value. Press **Enter**.

- The recalculated volumetric rate will be displayed.

5 Press **ok** to approve all displayed information and advance to the main hold page.

6 Press **RUN HOLD** or **run** to resume the infusion.

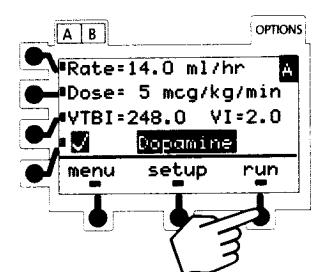
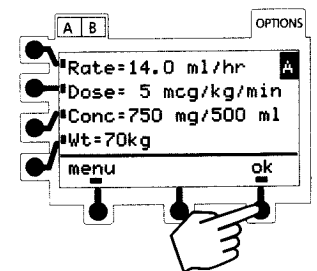
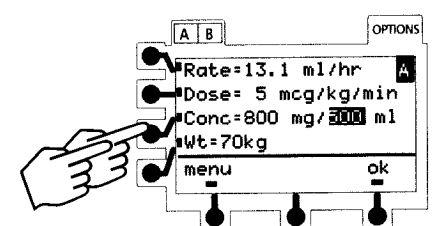
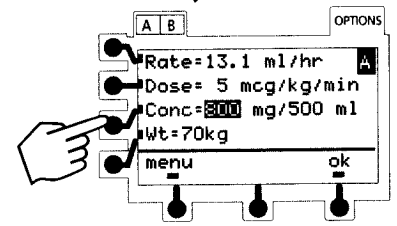
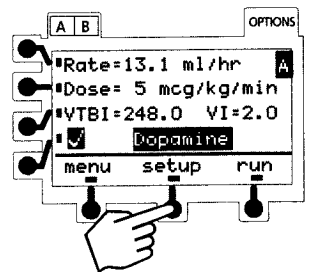

Resuming an Interrupted DRC Program

The channel will retain its place in the program up to six hours if the pump is turned off. After six hours, the channel will restart in the primary mode.

1 Press **POWER**.

- The Return to Dose Rate page will appear:

2 Press **yes**.

- Pressing **no** will return to the primary setup page.

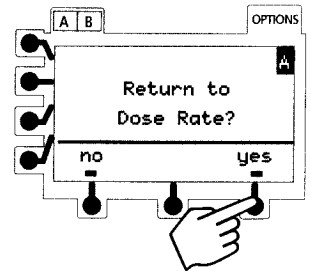

3 Press **Review/Resume** to access the setup parameters.

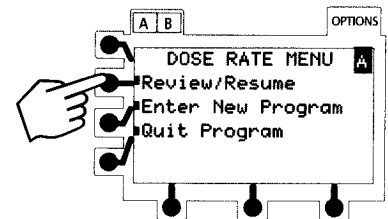

4 Press **ok** to verify the drug being infused and advance through the Dose Rate setup pages.

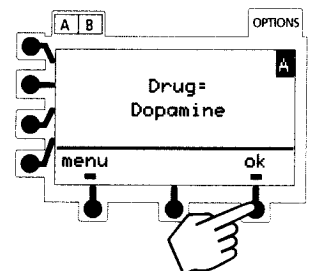

5 Press **RUN HOLD** or **run** to resume the infusion from the main hold page.

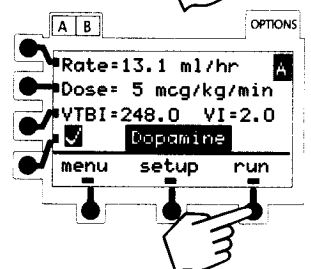

To Quit the DRC Program

The channel must be on hold.

1 Press **menu**.

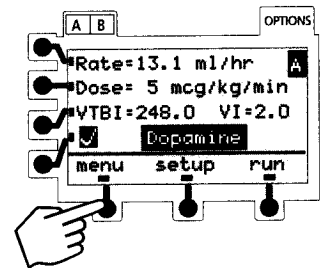

2 Press **Quit Program** to return to the primary setup page.

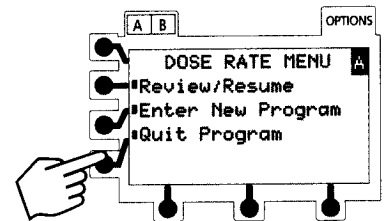

Multi-Step Program

This feature allows a sequential drug delivery program—up to nine steps—to be set, delivering volumes of fluid at different rates during each step. This allows the clinician to set up the pump parameters once and deliver a step profile—no need to change the rate and VTBI after each step of the infusion.

The infusion may be programmed in either **Rate and Volume** or **Volume and Time**.

At completion of the last programmed step, the channel will switch to the pre-set KVO rate or remain at the current rate, whichever is less.

Qualified service personnel can turn the Multi-Step feature on or off.

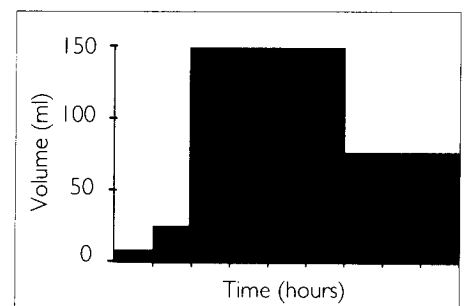

To Enter a New Program

Select desired channel, as necessary. The channel must be on hold in the primary mode, secondary mode, or a Loading Dose program.

- 1 Press **OPTIONS**.
 - The Options page will appear.
- 2 Press **Multi-Step**.
 - The MULTI-STEP MENU will appear.
- 3 Press **Enter New Program**.
- 4 Press a soft key to select the setup method.

If Rate and Volume is selected, the pump will calculate the step infusion time. Proceed to step 5.

If Volume and Time is selected, the pump will calculate the rate. Proceed to step 9.

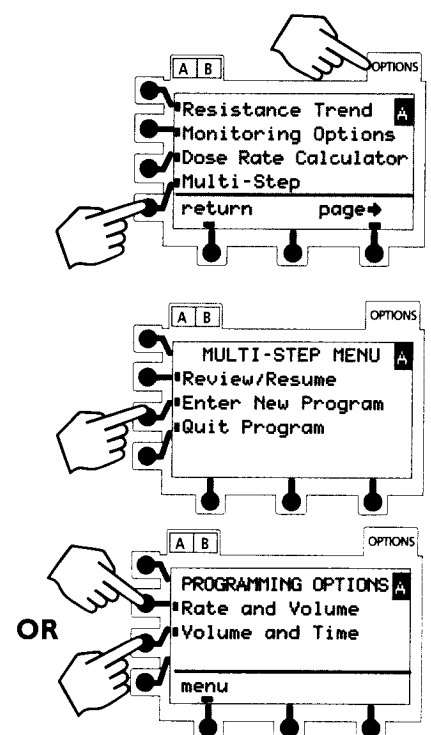

To Program by Rate and Volume:

5 Press **Rate and Volume**.

- STEP 1 of the infusion profile will be displayed.
- Rate will be highlighted.

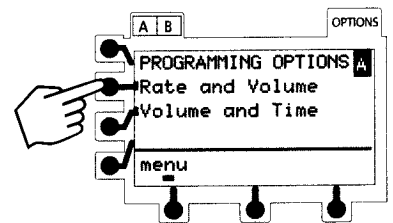

6 Use the numeric key pad to enter the rate. Press **Enter**.

- VTBI will be highlighted.

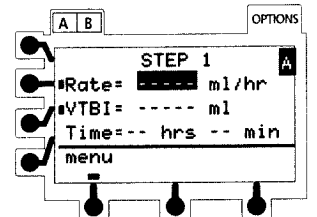

7 Use the numeric key pad to enter the VTBI. Press **Enter**.

- The pump will automatically calculate and display the time in hours and minutes.

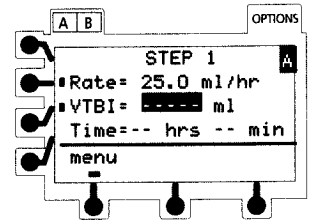

8 Press **ok** to approve all displayed information and advance to STEP 2 of the infusion profile.

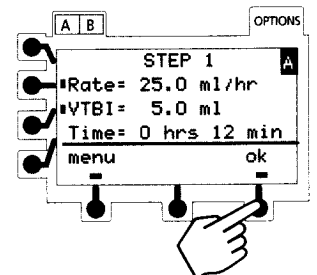

Repeat 6 through 8 above to set up each additional step of the infusion profile, then proceed to step 13.

To Program by Volume and Time:

9 Press **Volume and Time**.

- STEP 1 of the infusion profile will be displayed.
- VTBI will be highlighted.

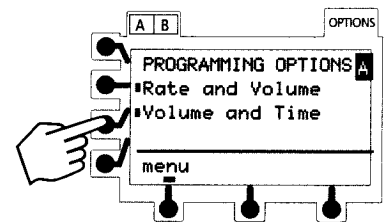

10 Use the numeric key pad to enter the VTBI.
Press **Enter**.

- Time (hours) will be highlighted.

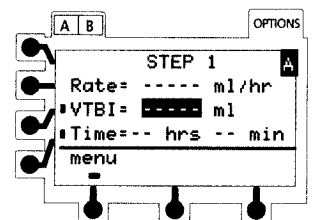

11 Use the numeric key pad to enter the hours.
Press **Enter**.

- Time (minutes) will be highlighted.
- Use the numeric key pad to enter the minutes, if desired.

Press **Enter**.

- The pump will automatically calculate and display the volumetric rate.

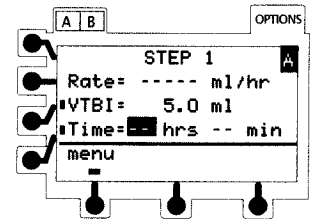

12 Press **ok** to approve all displayed information and advance to STEP 2 of the infusion profile.

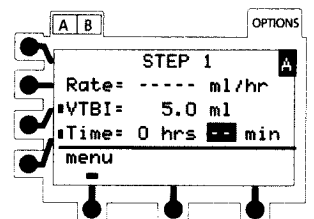

Repeat 10 through 12 above to set up each additional step of the infusion profile, then proceed to step 13.

13 When all the steps have been entered and **ok**'d, press **done**.

- Review page(s) will then display the profile three steps at a time.

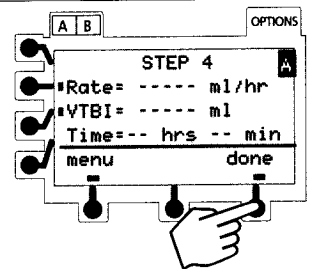

14 Press **ok** to approve and advance through the review page(s).

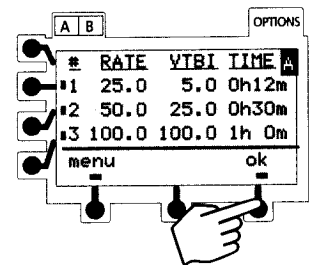

15 Press **Clear** or 0 (zero key) to clear the VI, if desired.

Press **Enter**.

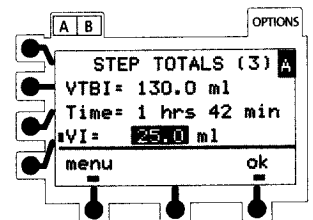

16 Press **ok** to approve the STEP TOTALS page.

- The main hold page will be displayed.

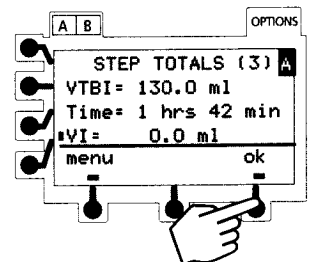

17 Press **RUN HOLD** or **run** to start the Multi-Step infusion program.

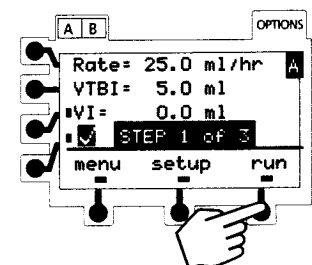

Making Changes During Multi-Step Program

Select desired channel, as necessary. The channel does not need to be on hold to clear the VI or to view the totals remaining.

To Clear the Volume Infused

- 1 Press **VI**.
- 2 Press **Clear** or 0 (zero key).
- 3 Press **Enter**.

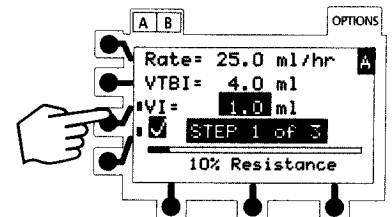

To View the Totals Remaining of the Multi-Step Program

- 1 Press **✓**.

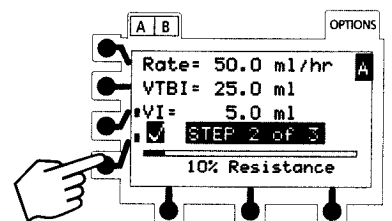

- The time and VTBI remaining in the Multi-Step program will be displayed for a short interval.

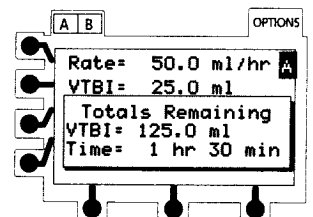

To View or Edit the Multi-Step Program

The channel must be on hold to view or edit the steps in the program.

- 1 Press **RUN HOLD** to place the channel on hold.

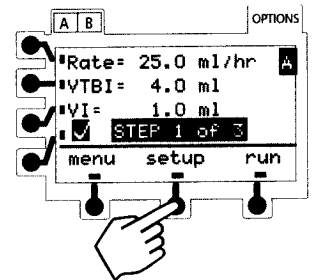

- 2 Press **setup** to return to the review page(s).

- A tick mark (■) next to a step on the review page(s) indicates that it has not started.
- Only steps with tick marks can be edited.
- Completed steps or a step in progress will *not* have a tick mark.
- A step number in progress will be highlighted.

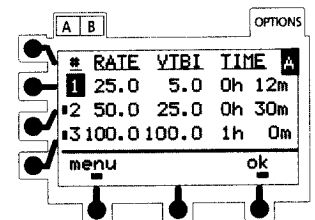

- 3 Press **ok**, if desired, to advance through the review page(s) of the program.

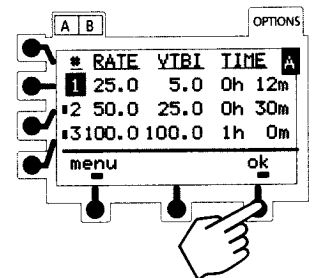

- 4 Press a soft key to select a step for editing.

- The step setup page will be displayed.

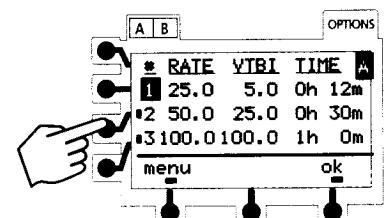

5 Press a soft key to select the value for editing.

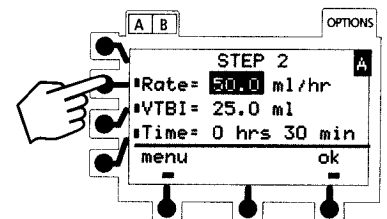

6 Use the numeric key pad to enter the new value. Press **Enter**.

7 Press **ok** when programming is complete to return to the review page(s).

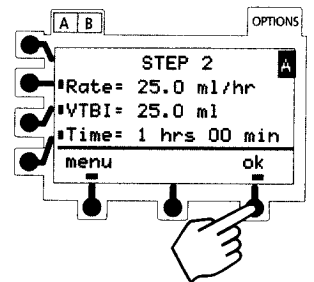

8 Press **ok** to approve the review page(s) and the STEP TOTALS page.

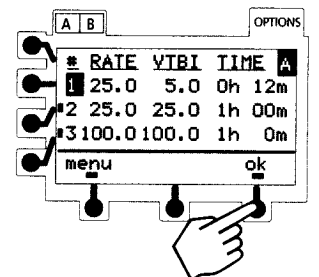

9 Press **RUN HOLD** or **run** to resume the infusion.

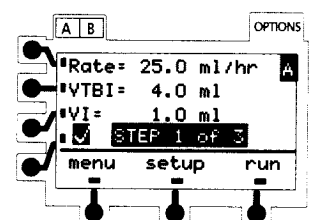

Resuming an Interrupted Program

The channel will retain its place in the program up to six hours if the pump is turned off; the program can be restarted from STEP 1 or resumed where it left off. After six hours, the channel will restart in the primary mode.

1 Press **POWER**.

- The Return to Multi-Step page will appear.

2 Press **yes**.

- Pressing **no** will return to the primary setup page.

3 Press **Review/Resume**.

- The STEP In Progress page will appear.

4 Press **Continue Program** to resume the program from the point of interruption.

OR

Press **Restart Program** to restart the program at the beginning of STEP 1.

- The review page(s) will appear.

5 Press **ok** to approve the review page(s) and the STEP TOTALS page.

6 Press **RUN HOLD** or **run** to continue or restart the program.

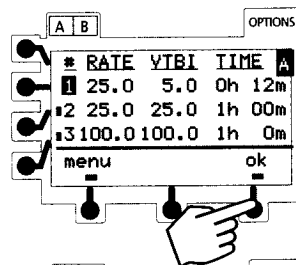
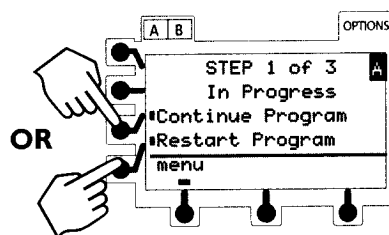
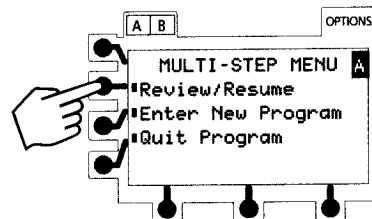
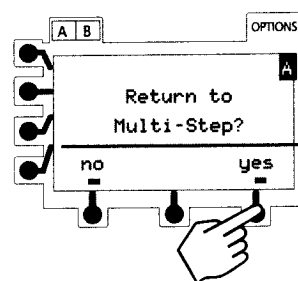

To Quit the Program

The channel must be on hold.

1 Press **menu**.

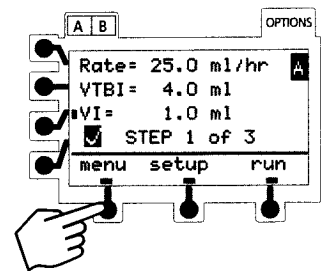

2 Press **Quit Program** to return to the primary setup page.

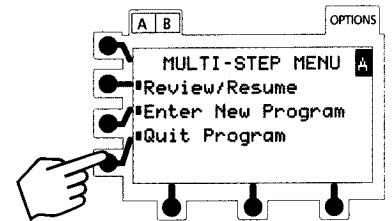

Multi-Dose Program

This feature permits the clinician to pre-program 1 to 24 infusions with the same rate and volume, over a period of up to 24 hours.

This feature also offers a delayed start option up to 8 hours and a Dose Complete Alert Option to alert the clinician of the completion of each dose delivered.

This program requires another infusing line to keep the vein open between programmed doses since there is no KVO infusion between doses or following program completion.

Qualified service personnel can turn the Multi-Dose and Dose Complete Alert Option features on or off.

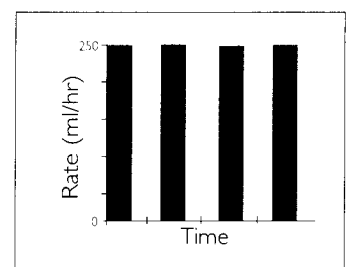

To Enter a New Program

Select desired channel, as necessary. The channel must be on hold in the primary mode, secondary mode, or a Loading Dose program.

1 Press **OPTIONS**.

- The Options page will appear.

Press **page** or **page** as necessary to view additional selections.

2 Press **Multi-Dose**.

- The MULTI-DOSE MENU will appear.

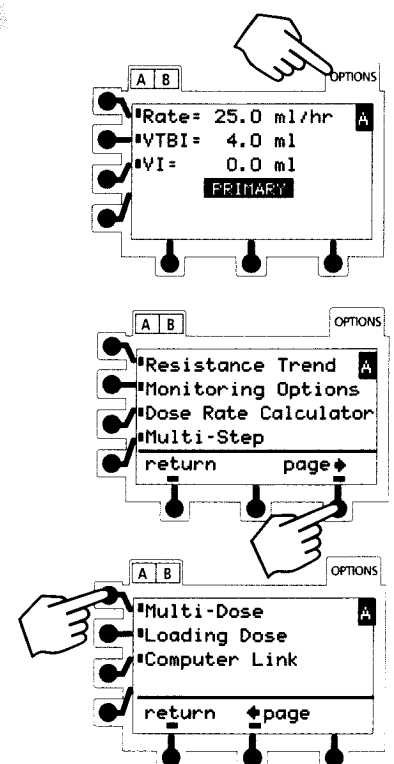

3 Press **Enter** **New Program**.

- The setup page will appear.
- The infusion rate will be highlighted.

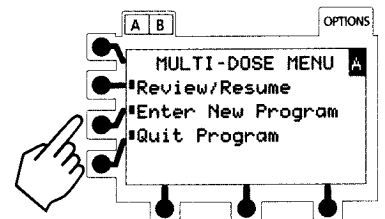

4 Use the numeric key pad to enter the infusion rate.

Press **Enter**.

- The VTBI/Dose (volume to be infused per dose) will be highlighted.

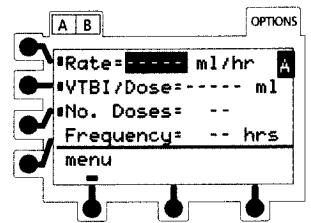

5 Use the numeric key pad to enter the VTBI/Dose.

Press **Enter**.

- The number of doses to be given will be highlighted.

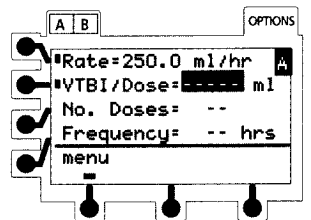

6 Use the numeric key pad to enter the number of doses.

Press **Enter**.

- The dose frequency will be highlighted.

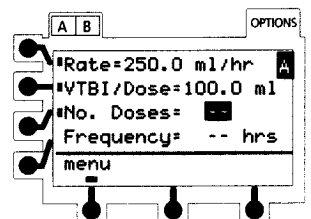

7 Use the numeric key pad to enter the dose frequency (time interval from the start of one dose until the start of the next).

Press **Enter**.

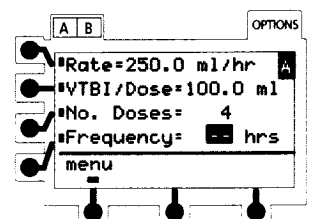

- 8** Press **ok** to approve all information.
 If the Dose Complete Alert Option is enabled:
- The DOSE COMPLETE ALERT OPTION page will appear.

- 9** Use the soft keys to select the option on or off.

- 10** Press **ok** to advance to the Time Until First Dose page.

NOTE: All doses must be programmed to start within 24 hours.

To start the first dose immediately, proceed to step 11.

To delay the start of the first dose, proceed to step 14.

To Start the First Dose Immediately After Programming

- 11** A displayed time of 0 hours, 0 minutes, identifies that the first dose will start immediately after programming.

- 12** Press **ok** to approve and advance to the main hold page.

- 13** Press **RUN HOLD** or **run** to start the infusion.

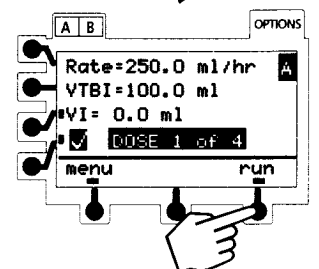
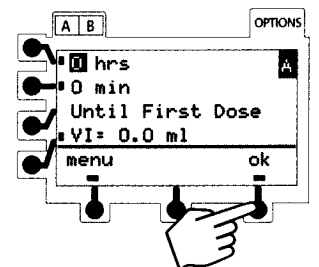
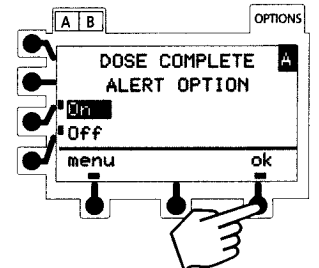
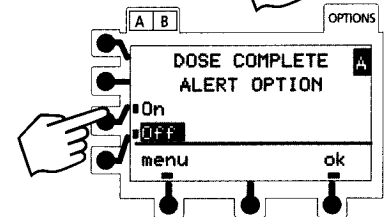
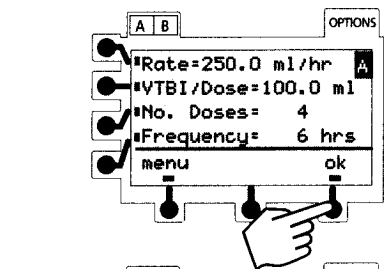

To Delay the Start of the First Dose

14 Use the numeric key pad to enter the number of hours until the first dose.

Press **Enter**.

- The number of minutes will be highlighted.

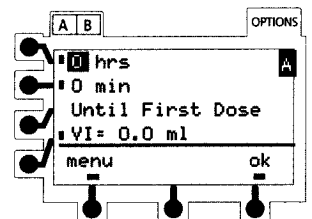

15 Use the numeric key pad to enter the number of minutes.

Press **Enter**.

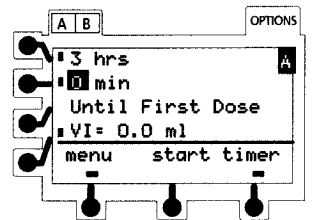

16 Press **start timer** to advance to the timer hold page.

- The hourglass icon will flash to indicate the timer is counting down to the start of the dose.
- The dose will automatically start its infusion when the timer reaches 0 hours, 0 minutes.

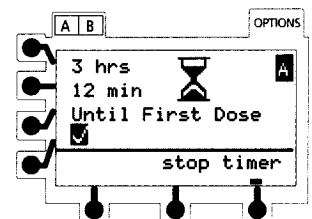
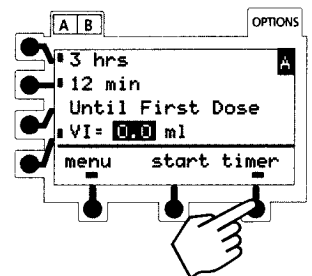

Making Changes During Multi-Dose Program

Select desired channel, as necessary. The channel does not need to be on hold to view more information.

To View More Information on the Multi-Dose Setup

1 Press .

- Additional Multi-Dose setup information will be displayed for a short interval.

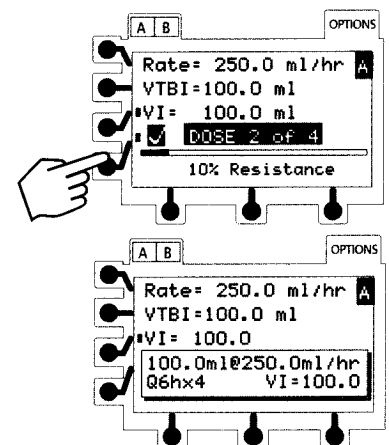

To Change the Time Interval Until the Next Dose

1 Press **stop timer**.

2 Press a soft key to select a value for editing.

3 Use the numeric key pad to enter the new value.

Press .

4 Press **start timer** when editing is complete.

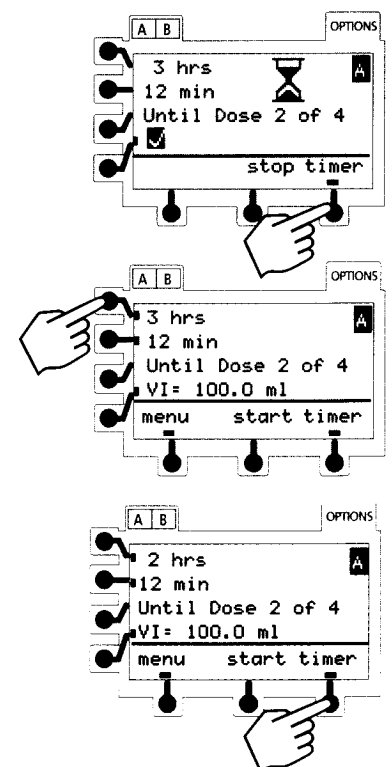

Resuming an Interrupted Program

The channel will retain its place in the program up to six hours if the pump is turned off; the program can be resumed where it left off. After six hours, the channel will restart in the primary mode.

1 Press **POWER**.

- The Return to Multi-Dose page will appear.

2 Press **yes**.

- Pressing **no** will return to the primary setup page.

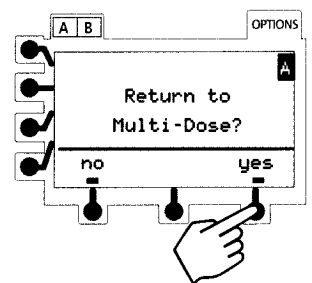

3 Press **Review/Resume** to access the setup parameters.

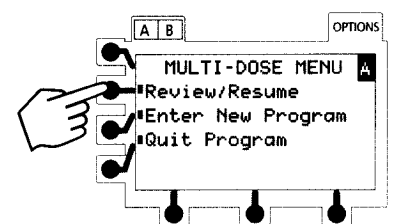

If the Infusion was in Progress When Interrupted:

4 Press **ok** to approve and advance to the main hold page.

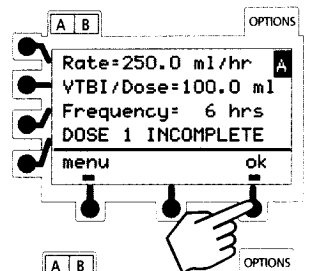

5 Press **RUN HOLD** or **run** to resume the infusion.

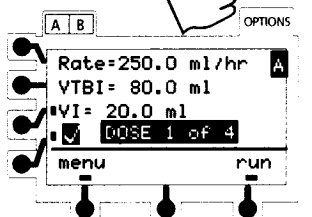

If the Infusion was Not in Progress When Interrupted:

- 4 Press **ok**.
- 5 Edit the time to delivery of the next dose, as necessary.
- 6 Press **start timer** to begin the timer's countdown to delivery of the next dose.

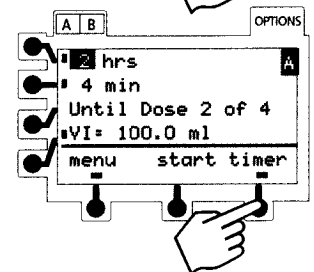
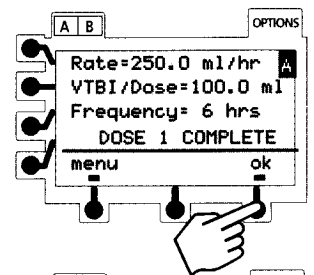

To Quit the Program

The channel must be on hold or the last dose complete.

- 1 Press **menu**.
- 2 Press **Quit Program** to return to the primary setup page.

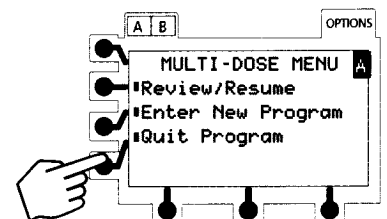
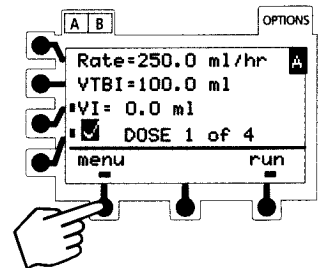

Loading Dose

This feature allows the clinician to set up an initial infusion rate for a specific volume, automatically followed by a maintenance rate (primary settings) from the same container. The primary VTBI and VI include the Loading Dose volumes. When the Loading Dose VTBI reaches zero, a transition tone will sound ( if the transition tone feature is enabled), **LoadDose Complete** message will be displayed for a few seconds, and the primary settings will automatically take effect.

This mode is useful for loading a medication prior to the start of a continuous infusion or delivering fluid challenges.

Qualified service personnel can turn the Loading Dose feature on or off.

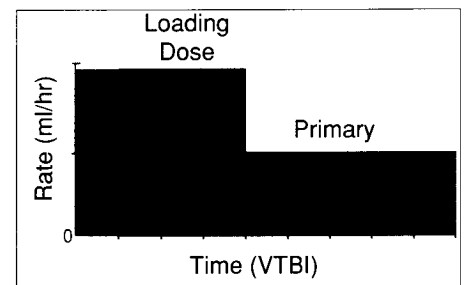

Entering a New Program

Select desired channel, as necessary. The channel must be on hold in the primary or secondary mode.

1 Press **OPTIONS**.

- The Options page will appear.

Press **page** or **page** as necessary to view additional selections.

2 Press **Loading Dose**.

- The Loading Dose infusion rate will be highlighted.

3 If the current value is appropriate, press **Enter**.

OR

Use the numeric key pad to enter a new infusion rate.

Press **Enter**.

- The Loading Dose VTBI will be highlighted.

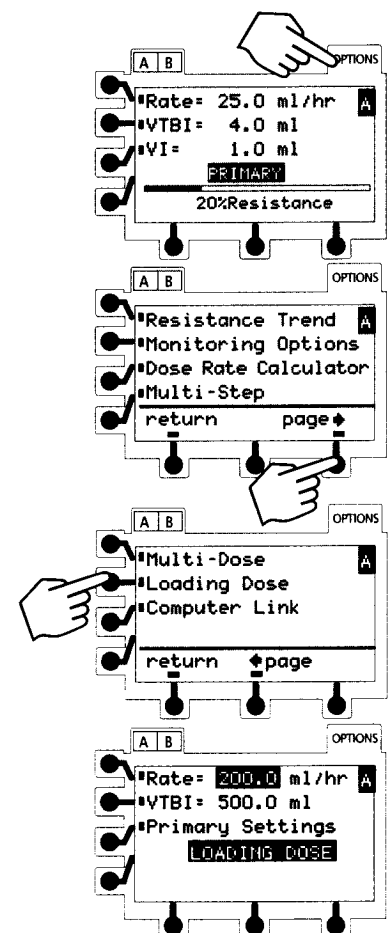

4 If the current value is appropriate, press **Enter**.

OR

Use the numeric key pad to enter a new VTBI.

Press **Enter**.

NOTES: The Loading Dose VTBI must be equal to or less than the primary VTBI.

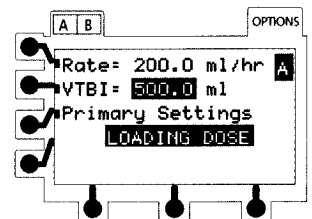

5 Press **RUN HOLD** to start Loading Dose infusion.

Making Changes During Loading Dose Program

Select desired channel, as necessary. The channel does not need to be on hold to change settings for Loading Dose Rate or VTBI.

1 Press the soft key for the value you want to change.

- Current value will be highlighted.

To Change Loading Dose Infusion Rate:

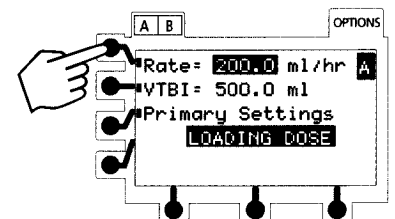

To Change Loading Dose Volume To Be Infused:

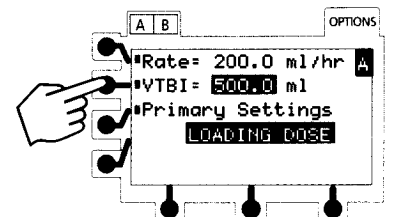

2 Use the numeric key pad to enter the new value.

3 Press **Enter** to accept new value(s).

To View or Change Primary Settings While Loading Dose is Infusing

Select desired channel, as necessary.

1 Press **Primary Settings**.

- Primary rate (**Pri Rate**), primary volume to be infused (**Pri VTBI**) and total volume infused (**Total VI**) will be displayed.
- The display will return to the normal Loading Dose page after 6 seconds.

2 Press **Pri Rate**, **Pri VTBI**, or **Total VI** to:

- "freeze" the display
- highlight the value

To Change Primary Rate While Loading Dose is Infusing:

To Change Primary VTBI While Loading Dose is Infusing:

NOTE: If the flow sensor option is being used, VTBI can be turned OFF by selecting VTBI, then pressing **Clear**

OR

Primary VTBI can be deleted from the primary mode setup page (Programmable Features).

To Clear Total Volume Infused While Loading Dose is Infusing:

3 Use the numeric key pad to enter new value.

OR

4 Press **Clear** or 0 (zero key) to reset volume infused to 0.0.

5 Press **Enter** to accept new value(s).

- The display will return to the normal Loading Dose page after 6 seconds.

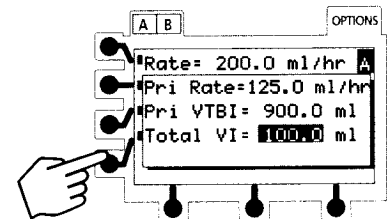
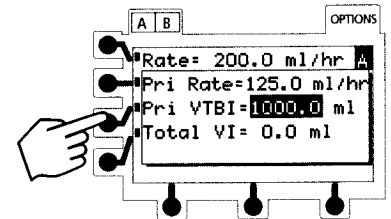
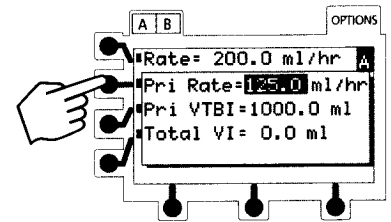
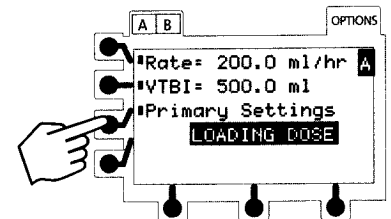

Resuming an Interrupted Loading Dose Program

The channel will retain its place in the program up to six hours if the pump is turned off. After six hours, the channel will restart in the primary mode.

1 Press **POWER**.

- The Return to Loading Dose page will appear.

2 Press **yes**.

- Pressing **no** will return to the primary setup page.

3 Press **RUN HOLD** to resume the infusion.

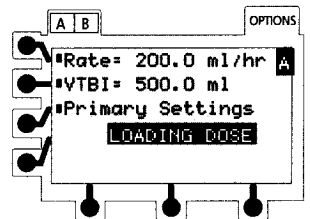
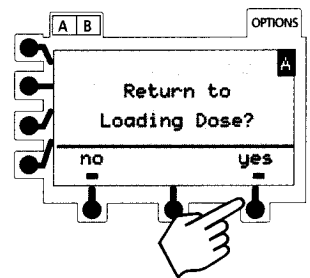

Computer Link

The optional Computer Link feature allows a hospital computer to interact with the pump. The computer cannot start or stop the pump, set the rate, or make any change in status. If the feature is off, the computer cannot communicate with the pump. Computer Link options available are:

- **Monitor mode**, which allows the computer to only receive information from the pump.
- **Control mode**, which allows the computer to send information to the pump's display. This information (e.g., drug being infused) will be displayed every 10 seconds.

Qualified service personnel can turn the Computer Link feature on or off.

To connect to a computer:

1 Press **OPTIONS**.

- The Options page will appear.

Press **page** or **page** as necessary to view additional selections.

2 Press **Computer Link**.

- The Computer Link page will appear.

3 Press **Monitor** or **Control**.

4 Press **ok**.

5 Connect an RS 232 cable from the hospital computer to the  on the instrument back panel.

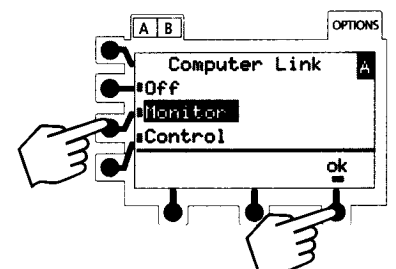
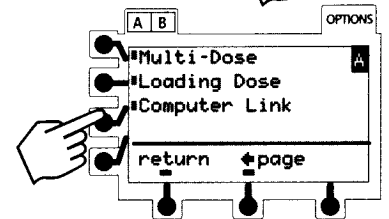
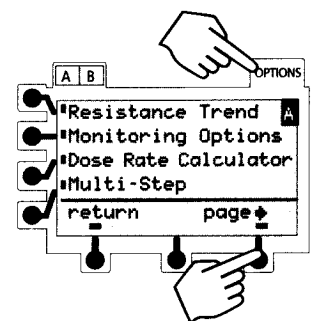

While the pump is waiting for a connection:

Control Mode - CTRL flashes

Monitor Mode - MNTR appears at connection

If communication is interrupted:

Control Mode - CTRL flashes until alarm answered

Monitor Mode - MNTR flashes for 60 seconds

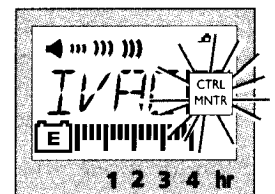

MNTR or CTRL will remain in the lower display once the mode is selected and communication with the computer has been established.

To disconnect from a computer:

1 Press **OPTIONS**.

- The Options page will appear:

Press **page** or **page** as necessary to view additional selections.

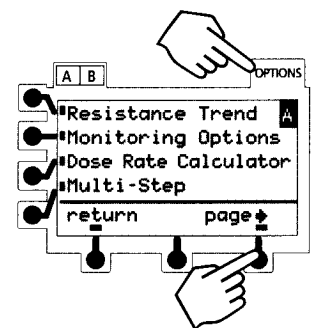

2 Press **Computer Link**.

- The Computer Link page will appear:

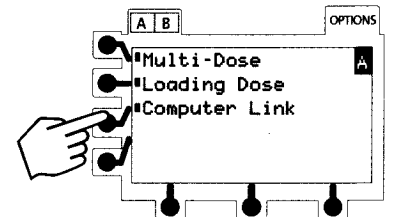

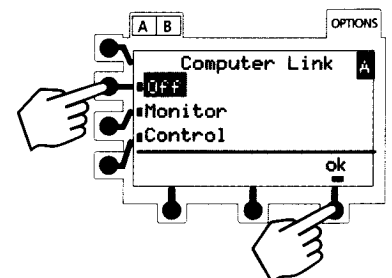

3 Press **Off**.

4 Press **ok**.



MAINTENANCE

Specifications

| | | |
|-----------------------------|--|---|
| FLOW RATE RANGE: | 0.1 to 999.9 ml/hr in 0.1 ml/hr increments (primary) 0.1 to 270.0 ml/hr in 0.1 ml/hr increments (secondary) |  |
| VOLUME TO BE INFUSED RANGE: | 0.1 to 9999.9 ml in 0.1 ml increments (primary) 0.1 to 999.9 ml in 0.1 ml increments (secondary) | |
| VOLUME INFUSED RANGE: | 0.0 to 9999.9 ml in 0.1 ml increments | |
| KVO FLOW RANGE: | 0.1 to 20.0 ml/hr in 0.1 ml/hr increments |  |
| ALARMS: | Air In Line Battery Depleted Channel Malfunction Computer Link Failure Flow Sensor Unplugged Hold Time Exceeded Instrument Malfunction Key Stuck | Latch Open Occlusion Downstream Occlusion Upstream No Upstream Flow Detected Primary Flow Detected during Secondary Set Out Set Up Time Exceeded |
| DIMENSIONS: | | |
| | <u>7100</u> | <u>7200</u> |
| Width | 7.6 in/19.3 cm | 10.5 in/26.7 cm |
| Height | 8.6 in/21.8 cm | 8.6 in/21.8 cm |
| Depth* | 5.0 in/12.7 cm | 5.0 in/12.7 cm |
| Weight** | 6.85 lbs./3.11 kg | 8.4 lbs./3.7 kg |
| Power Cord | 10ft/3 m | 10ft/3 m |
| | <i>*without pole clamp</i> | <i>**without power cord</i> |
| CASE: | Impact resistant plastic | |
| ADMINISTRATION SETS: | Use only IVAC 72 series administration sets. | |
| POWER REQUIREMENTS: | 100-120 V~, 50/60 Hz, 0.5A, 3-wire grounded system (40 watts max.) | |
| GROUND CURRENT LEAKAGE: | Tested to UL Standard 544 and CSA C22.2 No. 125 for medical and dental equipment. | |
| BATTERY: | Rechargeable nickel cadmium. With a new, fully charged battery, the pump will operate for 4 hours nominal at 100 ml/hr for a two channel instrument operating on both channels simultaneously. (See Battery Management System section of this document.) | |

ENVIRONMENTAL CONDITIONS:

| | Operating | Storage |
|-----------------------|---------------------------------|-----------------------------------|
| Temperature Range: | 10°C to 40°C (50°F to 104°F) | -40°C to 60°C (-40°F to 140°F) |
| Relative Humidity: | 15 to 90% Non-condensing | 5 to 95% |
| Atmospheric Pressure: | 632 to 1031 mbar | 632 to 1031 mbar |



Programmable Features

The following features can be customized by qualified service personnel.

| Feature | Options | Default |
|-----------------------------|--|----------------|
| Optional Modes: | | |
| Dose Rate Calculator | On/Off | On |
| Loading Dose | On/Off | On |
| Multi-Dose | On/Off | Off |
| Multi-Step | On/Off | Off |
| Air in line: | | |
| Air-in-line Alarm Threshold | 50, 100, 200, or 500 µl | 100 µl |
| Air-in-line Reset Feature | On/Off | Off |
| Audio: | | |
| Volumes | Low/Med/Hi Med/Hi Hi | Low/Med/Hi |
| Transition Tone | On/Off | On |
| Computer Link: | | |
| Baud Rate | 300/600/1200/1800/2400/4800/9600 | 9600 |
| Parity | Even/Odd/ None | None |
| Control | Control/Monitor/Off, Monitor/Off, Off | Off |
| Dynamic Monitoring: | | |
| AutoRestartPlus | 0 (Off) /1 to 9 | 3 |
| Alert Arrows | On/Off | Off |
| Alert Level | 5-100% | 100% |
| Monitoring Options | Resistance/High Resistance/Pressure Only | Pressure Only |
| Resistance Display | On/Off | On |
| Resistance Trend Graph | On/Off | On |
| Instrument ID | 9 digits | 000000000 |
| Instrument Label | 4 alpha-numeric | IVAC |
| KVO Rate | 0.1 - 20.0 ml/hr | 5.0 ml/hr |
| Languages | English/French | English |
| Maintenance: | | |
| Maintenance Interval | 1-52 wks | 52 wks |
| Maintenance Reminder | On/Off | Off |
| Maximum Rate | 0.1 - 999.9 ml/hr | 999.9 ml/hr |
| Panel Lock | On/Off | On |
| VTBI | On/Off (Flow Sensor use) | On |
| Multi Dose Alert | On/Off | Off |

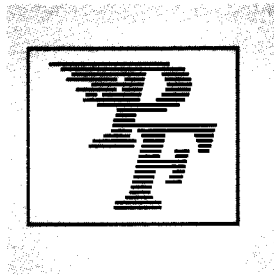

Unpacking

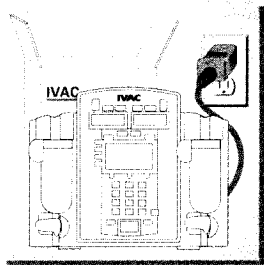

1. Remove the pump from its carton.
2. Plug into an AC outlet.
 - Maximum battery capacity, as well as gauge accuracy, is reached after several charge/discharge cycles. For best results, fully charge and discharge the battery 2-3 times before putting the pump into service.
3. Perform the Periodic Inspections as indicated on page 100.

See the PROGRAMMABLE FEATURES section of this document for a list of the configurable features. Complete programming instructions are in the Technical Service Manual.

Storage

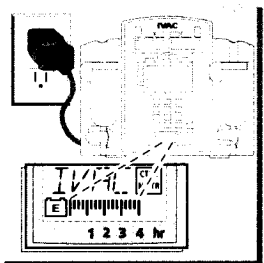

Plug the pump into an AC outlet during storage to ensure a fully charged battery when needed.

-  (AC indicator light) will be green whenever pump is plugged in.

Close the latch(es) whenever the pump is not in use.

Cleaning

- 1 Unplug the power cord from the AC outlet before cleaning.
 - 2 Use a soft cloth dampened with warm water and a mild, non-abrasive cleaning solution.
 - A soft-bristled brush may be used to clean narrow areas.
 - Use light pressure when cleaning the pressure transducer and air-in-line detector areas of the pumping channels.
 - Acceptable cleaning solutions (*Use per manufacturers' instructions*):
Warm water, Vesphene[®]*, Manu-Klenz[®]*, Glutarex[™]**
- DO NOT** use solutions containing aromatic solvents (naphtha, paint thinner, etc.), chlorinated solvents (Trichloroethane, MEK, Toluene, etc.), alcohol, or phosphoric acid.
- DO NOT** use hard or pointed objects to clean any part of the pump.
- DO NOT** steam autoclave, EtO sterilize, or immerse the pump.

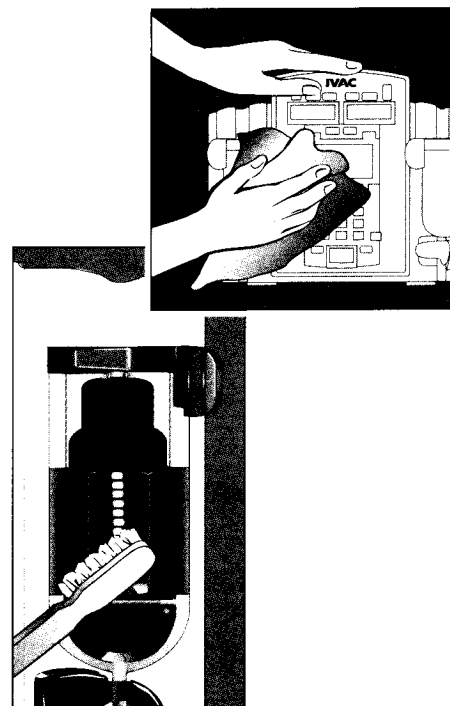

* Vesphene and Manu-Klenz are registered trademarks of Calgon Vestal Laboratories, Division of Calgon Corporation, Subsidiary of Merck & Co., Inc.
** Glutarex is a trademark of 3M Healthcare, Subsidiary of 3M

Inspection Requirements

To ensure the pump remains in good operating condition, both regular and periodic inspections are required.

Regular inspections consist of a visual inspection for damage and cleanliness, and performing the procedure described in the START UP SEQUENCE section of this manual before each usage of the instrument. Regular inspections are not covered under any contract or agreement offered by ALARIS Medical Systems and must be performed by the user.

Periodic inspections are recommended at the indicated intervals.

The periodic inspections listed are recommended in accordance with ALARIS Medical Systems requirements and guidelines. Customers within the United States and Canada should note that these inspections are also intended to complement the intent of the Joint Commission on the Accreditation of Healthcare Organizations requirements.

Detailed instructions for performing periodic inspections and maintenance can be found in the instrument Technical Service Manual and supplemental service bulletins. A service agreement may be obtained from ALARIS Medical Systems for the performance of all required periodic inspections.

For more information, see the SERVICE INFORMATION section, contact your local account representative, or contact ALARIS Medical Systems Customer Service **(800) 482-4822**.

WARNING: Failure to perform these inspections may result in improper instrument operation.

REGULAR INSPECTIONS

| PROCEDURE | FREQUENCY |
|---------------------|-------------|
| START UP SEQUENCE | Each usage |
| CLEANING | As required |
| INSPECT FOR DAMAGE: | |
| Case | Each usage |
| Power Cord | Each usage |

PERIODIC INSPECTIONS

| PROCEDURE | FREQUENCY |
|----------------------------|-----------|
| Physical Inspection | 12 months |
| Electrical Safety | 12 months |
| Self-tests | 12 months |
| Functional | 12 months |
| Rate Accuracy Verification | 12 months |
| Battery Refresh | 12 months |

Service Information

If the pump fails to respond as described in this manual and the cause cannot be determined, do not use the pump. Contact qualified service personnel.

Within the United States, application and service information may be obtained by writing to the ALARIS Medical Systems Service Department at:

ALARIS Medical Systems, Inc.
9190 Activity Road
San Diego, California 92126
ATTN: Instrument Service

Within the United States and Canada, a toll-free telephone number has been set up for your convenience. For information or assistance:

In the United States: **(800) 482-4822**
In Canada: *Eastern* — **(800) 908-9918**
Western — **(800) 908-9919**

Outside the United States and Canada, service information, applications, and manuals may be obtained by contacting your local ALARIS Medical Systems Service Department or distribution center.

When submitting any request for service, include:

- a description of the difficulty experienced
- instrument settings
- administration set/lot number
- solution used
- message displayed at the time of difficulty

If it is necessary to return the instrument for service, obtain a return authorization number prior to shipment. Carefully package the instrument (preferably in the original packaging), reference the return authorization information, and return it to the appropriate service or distribution center. ALARIS Medical Systems cannot assume any responsibility for loss of or damage to returned instruments while in transit.

WARRANTY

ALARIS Medical Systems, Inc., (hereinafter referred to as "ALARIS Medical Systems") warrants that:

- A. Each new IVAC Signature Edition Pump, excluding the battery, is free from defects in material and workmanship under normal use and service for a period of two (2) years from the date of delivery by ALARIS Medical Systems to the original purchaser.
- B. The battery and each new accessory are free from defects in material and workmanship under normal use and service for a period of ninety (90) days from the date of delivery by ALARIS Medical Systems to the original purchaser.

If any product requires service during the applicable warranty period, the purchaser should communicate directly with ALARIS Medical Systems headquarters (San Diego, CA) to determine the appropriate repair facility. Except as provided otherwise in this warranty, repair or replacement will be carried out at ALARIS Medical Systems expense. The product requiring service should be returned promptly, properly packaged and postage prepaid by purchaser. Loss or damage in return shipment to the repair facility shall be at purchaser's risk.

In no event shall ALARIS Medical Systems be liable for any incidental, indirect or consequential damages in connection with the purchase or use of any ALARIS Medical Systems product. This warranty shall apply solely to the original purchaser. This warranty shall not apply to any subsequent owner or holder of the product. Furthermore, this warranty shall not apply to, and ALARIS Medical Systems shall not be responsible for, any loss or damage arising in connection with the purchase or use of any ALARIS Medical Systems product which has been:

- (a) repaired by anyone other than an authorized ALARIS Medical Systems service representative;
 - (b) altered in any way so as to affect, in ALARIS Medical Systems' judgment, the product's stability or reliability;
 - (c) subjected to misuse or negligence or accident, or which has had the product's serial or lot number altered, effaced or removed;
- or
- (d) improperly maintained or used in any manner other than in accordance with the written instructions furnished by ALARIS Medical Systems.

This warranty is in lieu of all other warranties, express or implied, and of all other obligations or liabilities of ALARIS Medical Systems, and ALARIS Medical Systems does not give or grant, directly or indirectly, the authority to any representative or other person to assume on behalf of ALARIS any other liability in connection with the sale or use of ALARIS Medical Systems products.

ALARIS MEDICAL SYSTEMS DISCLAIMS ALL OTHER WARRANTIES, EXPRESS OR IMPLIED, INCLUDING ANY WARRANTY OF MERCHANTABILITY OR OF FITNESS FOR A PARTICULAR PURPOSE OR APPLICATION.

See packing inserts for international warranty, if applicable.